

REXEL

Denmans
REXEL GROUP

Lighting Solutions

For every sector
2026/27



OFFICE &
COMMERCIAL



EDUCATION



HEALTH &
SOCIAL CARE



SPORTS &
HIGHMAST



INDUSTRIAL &
HAZARDOUS AREA



RESIDENTIAL



LIGHTING
CONTROLS



Lighting for every sector



With so many options available in the lighting market, we're here to help you make the right choices, whatever the project, and get you what you need, where you need it, at the right price, and fast!

- 250+ Rexel and Denmans branches across the UK with a huge range of quality, high-performing products from trusted leading brands
- Greatest stocks ever with so much more than lighting available in branch
- 15,000 products also available for next day delivery
- Expertise in sourcing the rare or discontinued products you need (and we stock the unexpected so call us first!)
- Solutions for every sector: commercial, residential and industrial
- Lighting design service – see pages 4 & 5
- Numerous easy to install and time-saving solutions to make things easier for you!
- Click and collect in one hour
- Don't forget you can always grab a coffee in branch!

Help is at hand

- Speak to our experts in local branches or your Account Manager
- Our Digital Contact Centre is on hand to help with any questions: **0330 0450606**
- Email: **customersupport@rexel.co.uk**
- Live chat – (yes, it's a real person!) – **rexel.co.uk**

Doing the right thing

- All products are UKCA marked and certified as fully compliant to UK standards ensuring peace of mind for both you and your customers.
- We work closely with both suppliers and the Lighting Industry Association (LIA and ICEL) to ensure the highest standards of products that comply with all the industry regulations.
- We source all of our lighting products from a fully traceable, sustainable and ethical supply chain.

It's easy online!

You already know our branches are there with a welcome and a free coffee if you want to pop in to collect or get advice, but have you thought about the alternative - online ordering?

We've made it quick and easy to search and buy with no fuss. Here's just some of the great reasons to try us online:

Easy to search



- Check stock in real time/grid view with filters to help you search
- Personalised pricing when you log in
- Favourites and previously bought products, even when searching
- Digital catalogues – just add products to cart



Easy to order



- Create job lists, share and add to cart
- Easy basket builder – order in one click
- Request a quote online – fastest ever service!
- Convert quotes to orders in one click
- Download our improved app: for barcode scanning & more!

Download here to find out more!



Easy to get your products



- Free delivery* to UK locations
- Order by 5pm for FREE next day delivery of stock items
- Click and collect in 1 hour from 250+ branches across the UK
- Track and trace your orders live – Email/text notifications

*Refer to our web terms and conditions of purchase

Easy admin



- Easy access to your account details
- View invoice status, download/print/pay invoices online
- View account summary/statements/order history
- Online proof of deliveries



Lighting Design and Solutions



End to end support and expertise for all your lighting projects

When it comes to lighting projects and independent advice, Rexel can help! We offer a free of charge bespoke lighting design and consultancy service that will help you deliver a creative, energy efficient and cost-effective solution, whether your project is commercial, residential or industrial.

Our design team will ensure that your project adheres to all the required standards and regulations, offering peace of mind when it matters with our bespoke emergency lighting designs and solutions.

Rexel offer quality and reliable products from leading brands including our own brand, fit for any budget, providing the most competitive and cost-effective solutions. We can also incorporate lighting controls, both wired and wireless in any design, to help you live and work in a better light.



Contact us for more info:

Email the Lighting Design and Solutions Team:
lighting.solutions@rexel.co.uk



Look out for our new Designer Selection icon – products with this icon attached have been nominated by the Rexel Lighting Design team. This means they regularly select these products for use in projects and in designs because of their performance, quality and return on investment to the end client.

Here's how...

Stage 1: Survey, advice and calculations

A nationwide team of engineers professionally qualified to industry standards offering impartial advice.

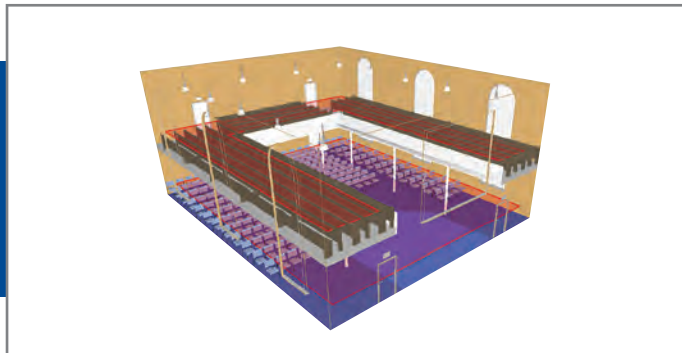

Stage 2: Design service

Technical design calculations and layouts are created using the latest RELUX software package, designed to conform to CIBSE/SLL guides and British Standards.



Stage 3: Quality products

We recommend only trusted products from the world's leading lighting manufacturers that meet our rigorous standards of performance, safety and quality.



Stage 4: Installation

Based on information that we have gathered from our survey and lighting designs, we can facilitate an installation service linking you with installers to give you a 'one-stop' solution which is fully project-managed. We can of course, also work on a supply only basis.



Design

Reality

Or download the Rexel App

REXEL

Denmans
REXEL GROUP

Contents

01 | Office & Commercial Indoor

Page 09

10
LED Panels
(Backlit) 

11
LED Panels
(Edgelit) 

12
Direct/Indirect
LED Panel 

12
Frame Effect
LED Panel 

13
Low Glare
LED Panel 

14
Bluetooth NLC Smart
LED Panel 

16
LED Edgelit Circular
Panel 

17
LED Commercial
Downlight 

18
LED Surface
Linear 

19
LED Batten 

20
LED Batten 

21
CCT & Power Switch
LED Batten 

22
Linear Office
Pendant 

24
Direct/Indirect
LED Pendant 

25
IP44 Bulkhead 

26
Indoor Bulkhead -
Colour & Wattage
Selectable 

27
Mini Multi Bulkhead
- Colour & Wattage
Selectable 

28
XL Bulkhead -
Colour & Wattage
Selectable 

29
Maxi Multi Bulkhead
- CCT Selectable 

30
Modular LED
Bulkhead 

02 | Office & Commercial Outdoor

Page 31

32
Square LED Bulkhead
- Colour & Wattage
Selectable 

33
LED Wallpack 

33
LED Polycarbonate
Wallpack 

36
LED Security &
Conduit Bulkheads 

36
LED Die-Cast
Aluminium Wallpack 

03 | Education

Page 37

38
CCT Switchable LED
Panels 

39
LED Panel
(Back Lit) 

40
LED Panel
(Back Lit)
High Efficiency 

41
Low Glare LED
Surface Linear 

04 | Health & Social Care

Page 43

44
LED Panel
- IP65 

46
LED Bulkhead 

47
LED Residential
Decorative Bulkhead 

48
IP65 LED Downlight 

48
Retrofit LED
Gear Tray 

05 | Retail & Hospitality

Page 49

50
LED Wall
Washer 

51
Adjustable
Downlight 

52
3 Circuit Track &
Accessories 

53
3 Circuit
Track Lights 

06 | Emergency

Page 55

58
LED Emergency
Bulkhead 

59
LED Emergency
Bulkhead 

59
Nebraska
Life 

60
LED Emergency Wall
Exit Box 

61
LED Emergency Slim
Wall Exit Box 

62
Lexington Life -
Lithium Battery 

63
LED Emergency
Suspended
Exit Sign 

64
LED Emergency Exit
Blade 

65
Arlington
Life 

66
Emergency Pin Spot
LED Downlight 

66
Emergency
Downlight 

67
Emergency
Conversion Kit 

68
Seneca
Recessed
LiFe 

68
Seneca
Surface
LiFe 

69
LED IP65
Emergency
Twinspot 

70
Emergency
Twinspot 

70
Kansas
LiFe 

07 | Industrial & Hazardous Area

Page 71

72
LED
Non-Corrosive 

73
LED
Non-Corrosive 

74
CCT & Power
Switchable
Non-Corrosive 

75
Clipless
Non-Corrosive 

76
Greenland PRO Non-
Corrosive 

77
Inspection
Pit Light 

78
LED
Highbay 

79
LED
Highbay 

80
All-in-One
LED Highbay 

81
LED
Lowbay 

82
LED Commercial/
Industrial
Floodlights 

83
LED Commercial/
Industrial Floodlight
- Asymmetric 

84
High Power LED
Floodlight



86
Zone 1
Linear LED



87
Zone 1
Linear LED



88
Zone 2
Linear LED



89
Zone 1
Area / Flood
Light



89
Zone 2
Area / Flood
Light



08 | Sports & High Mast

Page 91

92
Sports Floodlight
Asymmetric Beam



94
Indoor Sports
Lowbay



09 | Street & Amenity

Page 95

96
LED Street
Light



98
LED Street
Head



99
Cireco LED
Street Head



100
Post Top
Amenity
Street Light



101
Post Top
Spherical
Street Light



102
LED
Bollard



103
Modern LED
Wallpack



104
Street Lighting
Cutout



104
Street Lighting
Cutouts and
Accessories



10 | Site, Temporary & Portable

Page 105

106
Anti Corrosive
Site Lights



107
Anti Corrosive
Site Lights with
Junction Box



107
Anti Corrosive
Site Light
Accessories



108
Dual Voltage
Site Bulkheads



108
Site Globe
Lights



109
Site Festoon
Kits



110
Site
Floodlights



110
Site Emergency
Lights



111
Hand Held
Site Lights



111
Rechargeable
Site Light



112
Inspection &
Worklights



11 | Coastal

Page 113

114
LED Outdoor
Bulkhead



114
GU10 Wall and
Ground Lights



115
Billbao Coastal
Wall Lights



115
Norcia Coastal
Wall Light



12 | Residential Indoor

Page 117

118
LED Fire Rated
Downlights



119
LED Fire Rated
Downlight Wattage
/Colour Selectable



120
LED Fire Rated
Downlight Wattage
/Colour Selectable



121
LED PIR
Integrated
Downlight



122
LED Mini
Fire Rated
Downlight



123
LED Fire Rated
Downlight
with 2-Part Fix



125
Fire Rated
GU10
Downlight Can



126
240V GU10
Downlight Frame
& Bezels



128
Evofire Fire
Rated GU10
Downlights



129
Evofire Fire Rated
240V MR11
Downlights



130
Single Circuit
Track & Accessories



132
GU10
Spotlights



133
Decorative
Shades &
Pendants



134
Linkable LED
Undershelf
Lights



134
Indoor
Domestic
Battens



135
LED
Undercabinet Lights



135
LED Plinth
Lights



136
LED
Shaverlight



136
LED
Shaverlight



13 | Residential Outdoor

Page 137

138
LED Residential
Floodlights



139
CCT Switchable
Residential
LED Floodlight



140
GU10 Wall and
Ground Lights



141
GU10
Up/Down
Lights



142
Anti-Glare
Residential
Floodlight



143
LED Twin Head
Polycarbonate
Floodlight



143
LED Twin Head
Aluminium
Floodlight



144
Wall & Coach
Lanterns
- Black



144
LED Brick
Lights



145
Contemporary
Wall Lanterns



146
Modern Linear
Wall Light



146
Rust Effect
Wall Lantern



147
Compact
LED Security
Bulkhead



147
LED Residential
Outdoor
Bulkhead



148
Mains Voltage
LED Ground
Lights



148
Low Voltage
LED Ground
Lights



149
Mains Voltage
LED Spike
Lights



149
Low Voltage
LED Spike
Lights



150
Universal Outdoor
LED Spotlight



Contents

150
LED Decking
Kit



151
Colour Changing
LED Floodlight



152
Garden
Spike Kit



153
Outdoor
Lighting
Festoon



154
Decorative
Bollard



154
Residential
Bollard



155
LED Solar
Floodlight



156
Solar
Lighting



14 | LED Strip

Page 157

158
12V LED
Flexi Strip
Single Colour



160
24V LED
Flexi Strip
RGBW



162
24V LED
Spotless
COB Strip



164
LED Strip
Extrusion



165
24V LED
Free Cut
Strip



15 | Lamps

Page 169

170
LED GLS



171
CorePro LED
Frosted GLS
Non Dimmable



171
Master Value
LED Frosted
GLS Dimmable



172
Master GLS
Dimtone



172
GLS Photocell
Sensor



173
LED Candles



174
CorePro LED
Filament Candle
Non Dimmable



174
Master Value LED
Filament Candle
DimTone



175
CorePro LED Golfball
Non Dimmable



176
Decorative
Filament Lamps



177
CorePro
LED MR16
Non Dimmable



177
Master Value
LED MR16 Dimmable



178
LED GU10



179
35mm
LED GU10



179
CorePro
LED GU10



180
LED T8
Tube



181
Ultra Efficient
LED T8
Tubes



181
CorePro
LED Tube



182
Master
LEDtube
T5 Mains



183
CorePro
LED PLS



183
CorePro
LED PLC
2pin



184
CorePro
LED PLC
4pin



184
CorePro
LED PLT
4pin



185
CorePro
LED PLL



186
2D LED
Replacement



187
TrueForce
SON-T
Replacement



187
LED Corn Lamp



16 | Lighting Connection & Distribution

Page 189

190
Lighting Control
Module Kits



191
Marshalling
Boxes



192
Pre-wired
Plug-in Ceiling
Roses 3pin



192
Pre-wired
Plug-in Ceiling
Roses 4pin



193
3 Pin
Pre-wired
6A Plugs



193
4 Pin
Pre-wired
6A Plugs



194
Plug-in
Ceiling Roses
& Covers



194
Plugs &
Sockets



195
Lighting
Control
Modules



195
Luminaire
and Sensor
Leads



195
Commissioning
Tools



196
Lighting
Connector
Plugs



17 | Lighting Controls

Page 197

198
Wall & Ceiling
Mounted
Occupancy
Detectors



199
Exterior PIR
Sensors



202
Green-i
Sensor
Range



203
PIR
Detectors



203
Microwave
Detectors



204
Outdoor
Sensors



205-206
Photocells



18 | Lighting Control Gear & Accessories

Page 207

208-211
LED
Drivers



212
(NiCD) Emergency
Lighting Batteries



212
Sealed Lead
Acid Batteries



213
Emergency
Lighting Batteries



214-215
Lampholders and
Accessories



All information correct at time of going to print. E. & O.E. Unless indicated otherwise, all equipment featured in this catalogue is produced by third party manufacturers.

01 | Office & Commercial Indoor

Scan here to see our
full range online



LED Panels (Backlit)



5
YEAR
WARRANTY
30,000 Hours

IP20

CLASS
2

Suitable for a wide range of applications such as breakout areas, offices and meeting rooms and any other general indoor area. They can also be suspended, or surface mounted with additional kits. Plug and play emergency kits available for all variants.

- 600x600mm, 1200x600mm and 1200x300
- Available as standard TPb for 600x600 and 1200x600 types and TPa office compliant for 600x600 and 1200x300
- Plug in 3 hour emergency pack available
- Surface mount/suspension kits available

Order No.	Model No.	Description	Wattage (W)	Lumens (lm)	Efficacy (lm/w)	Colour Temp. (K)
LED PANELS (BACKLIT)						
2503011047	911401849687	TP(b) 600x600 LED Panel	28	3400	120	4000K
2503011048	911401849787	TP(a) 600x600 LED Panel UGR19	28	3400	120	4000K
2503011049	911401849887	TP(a) 1200x300 LED Panel UGR19	28	3400	120	4000K
2503011050	911401849987	TP(b) 1200x600 LED Panel	50	6000	120	4000K

Order No.	Model No.	Description
ACCESSORIES		
2501510676	919013004905	Remote Emergency Pack
2503011051	919313000701	High Output Remote Emergency Pack
2503015261	911401853387	DALI Driver Kit for 600x600 and 1200x300 Panels
2501510672	911401824280	Suspension Kit
2501510673	911401862982	Surface Mount Kit 600x600
2501510675	911401863082	Surface Mount Kit 1200x300
2501510674	911401864784	Surface Mount Kit 1200x600
2503015260	911401809287	Plasterboard Mounting Kit





LED Panels (Edgelit)



5
YEAR
WARRANTY
50,000 Hours

IP44

Suitable for a wide range of applications such as offices and meeting rooms and any other general indoor area. They can also be suspended or surface mounted with additional kits.

-  Rigid aluminium frame in white RAL9016
-  Simple installation with loop-in/loop-out ENEC branded driver
-  Flicker free LED driver
-  Separate plug in emergency kit to convert standard panel into emergency 3 hour option
-  Emergency comes with LiFePO4 batteries



Order No.	Model No.	Description	Wattage (W)	Lumens (lm)	Efficacy (lm/W)	Colour Temp. (K)
LED PANELS (EDGELIT)						
2501157621	NFU/O/66/840	600x600 LED Panel TP(b)	29	3465	120	4000K
2501157623	NFU/UGR19/66/TPA/840	600x600 LED Panel TP(a) UGR19	29	3475	120	4000K
2501157622	NFU/O/126/840	1200x600 LED Panel TP(b)	55	6370	116	4000K

Order No.	Model No.	Description
ACCESSORIES		
2501157624	N/REC/M3/PACK/V2	Remote Emergency Pack LiFePO4
2501376522	N/REC/STM3/PACK/V2	Remote Self-Test Emergency Pack LiFePO4
2501157625	NFU/WIRE/SUSP/KIT	Wire Suspension Kit for Panel
2501157626	NFU/SMK/66	Surface Mounting Kit for 600x600 Panel
2501157627	NFU/SMK/126	Surface Mounting Kit for 1200x600 Panel

Direct/Indirect LED Panel



Sigma is a high performance LED recessed luminaire, designed for low glare applications. RAL9016 white coated steel body featuring a central micro-prism optic and opal side diffuser to assist with LG7 compliant designs. Designed with unique swing-tabs giving flexible installation perfect for low-void grid ceilings to plasterboard.



- White painted steel body with central microprism optic and opal side diffuser optic
- Suitable for office environments UGR<19
- Suitable for recessed lay-in mounting or pull up surface mounting
- CRI>80
- Designed for full LG7 compliance



Order No.	Model No.	Description
DIRECT/INDIRECT LED PANEL		
2503027211	LSP66W28S40-01	Fixed Output 2800lm
2503027212	LSP66W35S40-01	Fixed Output 3500lm

Frame Effect LED Panel



Designed to deliver functional general lighting in an architecturally interesting way the LuxFrame Panel offers a solution which is that little bit different. The panel is semi-recessed mounted in 15mm or 24mm exposed grid ceilings with the ceiling tile placed onto the fixture.



- Emergency and DALI versions available on request



Order No.	Model No.	Description	Wattage (W)	Lumens (lm)	Colour Temp. (K)
FRAME EFFECT LED PANEL					
2501138574	LPSF66W20S40-01	Fixed Output 2000lm	22	2000	4000K
2501138587	LPSF66W28S40-01	Fixed Output 2800lm	31	2800	4000K
2503027219	LPSF66W35S40-01	Fixed Output 3500lm	41	3500	4000K

Low Glare LED Panel



The Luxpanel Octa from Luceco is the perfect lighting solution for offices and classrooms, combining high efficiency with a sleek, modern design. Engineered for balanced, low glare illumination, it creates a comfortable and productive environment while reducing energy consumption. Its slim, stylish build seamlessly integrates into standard ceiling grids, offering a clean and professional finish.



- Remote driver with LENNEL connector
- UGR<16 ultra low glare
- High efficiency ~194lm/w
- DALI variant available on request
- Long life 100,000hrs

Order No.	Model No.	Description	Wattage (W)	Lumens (lm)	Efficacy (lm/W)	Colour Temp. (K)
LOW GLARE LED PANEL						
2503027202	LBO66A29S40-01	TP(a) Fixed Output 2900lm	15	2900	193	4000K
2503027201	LBO66A35S40-01	TP(a) Fixed Output 3500lm	18	3500	194	4000K
2503046865	LED3EP1004W-01	Emergency Kit				

Find out more about our **Lighting Design and Solutions**

See pages 4 & 5 for details or email the team today at lighting.solutions@rexel.co.uk



Bluetooth NLC Smart LED Panel



The LuxPanel Connect is a high-performance LED panel with a seamlessly integrated Bluetooth NLC sensor. It is also the first LED luminaire in Europe to be certified as compliant with the new Bluetooth NLC standard. With market leading features such as adjustable motion sensitivity, default un-provisioned behaviour and a CRI Ra of over 90, it provides seamless system inter-operability, energy efficiency, and enhanced user control.



- Out-of-the-box Smart solution
- Inbuilt PIR motion sensor
- Controllable with Luceco Platform App
- Compatible with full Luceco Platform ecosystem
- CRI >90
- UGR<19 compliant



Order No.	Model No.	Description	Wattage (W)	Lumens (lm)	Efficacy (lm/W)	Colour Temp. (K)
BLUETOOTH NLC SMART LED PANEL						
2503027204	LPBC66W35LPW940PIR-01	TP(α) Bluetooth 600x600 LED Panel 3500lm	27.5	3500	130	4000K
2503027209	LPWDWS-01	2-Gang Kinetic Switch				

LUCECO

PLATFORM

WIRELESS LIGHTING CONTROLS

Upgrade existing lighting or create new installations with an intelligent, wireless communication system.

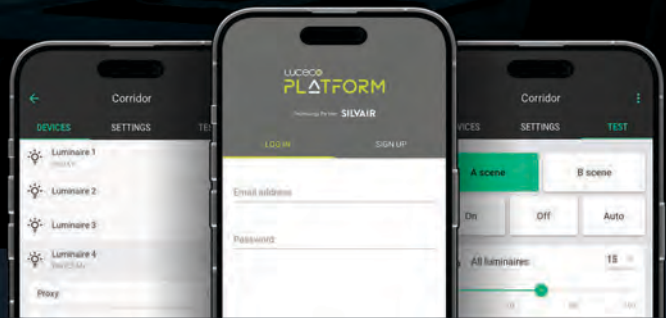

PROFESSIONAL LIGHTING **FOR SPECIFICATION**

Based on the globally interoperable, open standard Bluetooth mesh.

- ✓ Lower energy use, greater savings
- ✓ Wireless technology for scalable projects
- ✓ Quick, non disruptive installation

Available to download now



Scan the QR code
to find out more

LED Edgelit Circular Panel



3
YEAR
WARRANTY
30,000 Hours

IP20

**CRI
80+**

CLASS
2

A range of circular panels suitable for replacing downlights or compact fluorescent (CFL) downlights with cut-outs from 110mm to 210mm. Suitable for use in commercial and residential general indoor lighting applications.



- Material Construction:
 - Aluminium frame - white RAL9016
 - Opal polycarbonate diffuser

- Plug-in emergency
3hr kit available

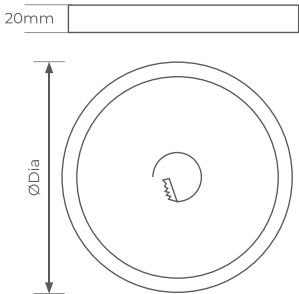

Order No.	Model No.	Description	Wattage (W)	Lumens (lm)	Efficacy (lm/W)	Cut Out (mm)	Colour Temp. (K)
LED EDGELIT CIRCULAR PANEL							
2501120799	ELP12W6L40	120mm LED Circular Panel	6	360	60	110	4000K
2501120800	ELP15W9L40	150mm LED Circular Panel	9	630	70	130	4000K
2501120801	ELP17W12L40	170mm LED Circular Panel	12	900	75	160	4000K
2501120802	ELP22W18L40	220mm LED Circular Panel	18	1530	85	210	4000K

Order No.	Model No.	Description
ACCESSORIES		
2503010998	LED3EP2W-01	Emergency Pack

LED Commercial Downlight



An integrated LED downlight replacement for compact fluorescent (CFL) downlights with cut-outs from 175mm to 210mm. Suitable for general indoor commercial lighting applications such as offices and corridors.

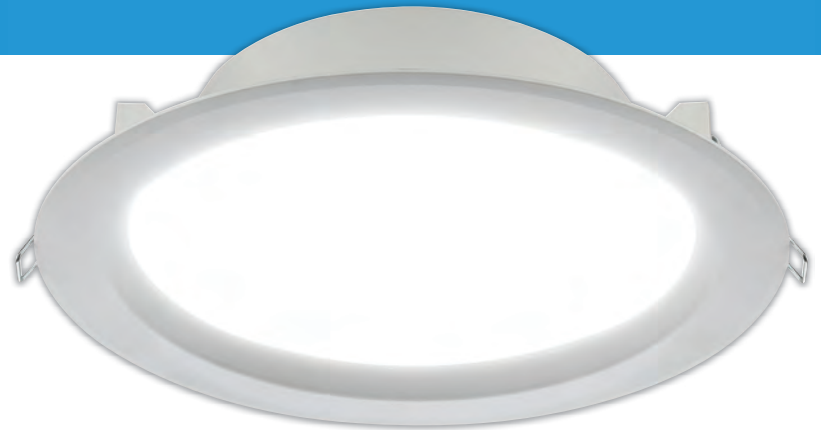

- Material Construction:**
- Aluminium body - white RAL 9016
 - Polycarbonate housing
 - Opal polycarbonate diffuser - self extinguishing TP(b) rated

Plug-in emergency 3hr kit available

Quick and easy install with plug and play loop in loop out driver

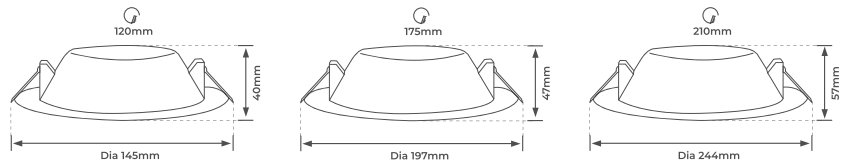

Order No.	Model No.	Description	Wattage (W)	Lumens (lm)	Efficacy (lm/W)	Cut Out (mm)	Colour Temp. (K)
LED COMMERCIAL DOWNLIGHT							
2500970656	LBDL4S40	145mm LED Commercial Downlight	9.5	1000	105	120	4000K
2501120804	LBDL6S40	197mm LED Commercial Downlight	13.5	1500	111	175	4000K
2501120805	LBDL8S40	244mm LED Commercial Downlight	18	2000	111	210	4000K



Order No.	Model No.	Description
ACCESSORIES		
2503010998	LED3EP2W-01	Emergency Pack for Circular Panel and Commercial Downlights

LED Surface Linear



The new improved Navara Pro MultiWattage & CCT LED battens are a simple and cost-effective solution for a wide range of commercial and retail applications. 4 selectable wattages & 3 CCT within each fitting, Push wire terminals for plug and play installation and now complete with a hinged diffuser making it easier and therefore quicker to install saving time for the installer.



-  Material Construction
 - Body: Powder coated mild steel
 - Diffuser and end caps: Polycarbonate
-  Power and colour switchable
-  Dimming and corridor function variants available on request

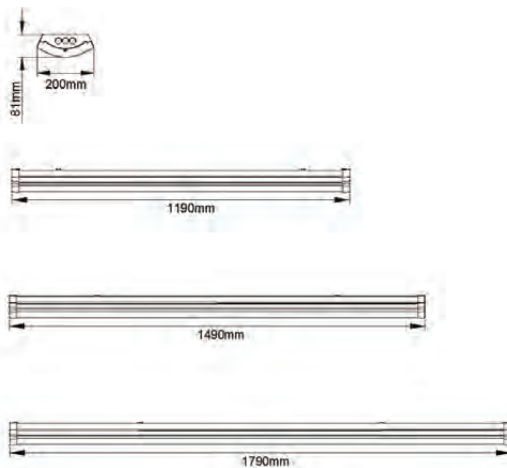

Order No.	Model No.	Description	Wattage (W)	Lumens (lm)	Emergency	Colour Temp. (K)
LED SURFACE LINEAR						
2501508508	KSR98190	4ft LED Surface Linear	21/27/32/38	2475-4185	-	3000/4000/6000K
2501508438	KSR98190/EM	4ft LED Surface Linear	21/27/32/38	2475-4185	Yes	3000/4000/6000K
2501508507	KSR98192	5ft LED Surface Linear	32/41/50/58	3725-6890	-	3000/4000/6000K
2501508466	KSR98192/EM	5ft LED Surface Linear	32/41/50/58	3725-6890	Yes	3000/4000/6000K
2501508506	KSR98194	6ft LED Surface Linear	36/46/55/65	4130-7320	-	3000/4000/6000K
2501508477	KSR98194/EM	6ft LED Surface Linear	36/46/55/65	4130-7320	Yes	3000/4000/6000K

LED Batten







5
YEAR
WARRANTY
35,000 Hours

IP20

CLASS
1

**DESIGNER
SELECTION**

A range of LED batten luminaires, ideal for new installations and retrofit in industrial, commercial and retail applications.

-  Material construction
 - Powder coated mild steel body
 - Polycarbonate end caps and diffuser
-  Suitable for direct fix, trunking and conduit mounting
-  Push wire terminals for plug and play installation
-  Plug-and-Play emergency and microwave sensor kits available
-  62mm Wide



Order No.	Model No.	Description	Wattage (W)	Colour Temp. (K)
LED BATTEN				
2501608927	KSR98310	4ft LED Single	11/14/17/20	4000K
2501608929	KSR98311	4ft LED Twin	21/27/32/38	4000K
2501608930	KSR98312	5ft LED Single	18/22/27/32	4000K
2501608931	KSR98313	5ft LED Twin	29/36/44/52	4000K
2501608932	KSR98314	6ft LED Single	22/28/34/40	4000K
2501608933	KSR98315	6ft LED Twin	33/42/51/60	4000K
2503000324	KSR98310/EM	4ft LED Single Emergency	11/14/17/20	4000K
2503000325	KSR98311/EM	4ft LED Twin Emergency	21/27/32/38	4000K
2503000326	KSR98312/EM	5ft LED Single Emergency	18/22/27/32	4000K
2503000327	KSR98313/EM	5ft LED Twin Emergency	29/36/44/52	4000K
2503000328	KSR98314/EM	6ft LED Single Emergency	22/28/34/40	4000K
2503000329	KSR98315/EM	6ft LED Twin Emergency	33/42/51/60	4000K

Order No.	Model No.	Description
ACCESSORIES		
2501597982	KSR98189	Emergency Pack - Standard & Self Test Selectable
2501597977	KSR98195	Plug and Play On/Off Microwave Sensor
2501245470	KSR8409	Batten Mount IP65 PIR Sensor





LED Batten



5
YEAR
WARRANTY

IP20

Ecolink battens are part of the Ecolink range offering high quality, reliable and lighting solutions for your projects. The Ecolink batten is available in 4, 5 and 6ft lengths and offers up to 7800lum of high-quality. The range is focused on energy efficiency and offers 120lum/W across.

-  Material construction:
Body: Steel
Diffuser: Polycarbonate
-  Easy installation with BESA fixing points
-  High quality Philips driver
-  CRI > 80

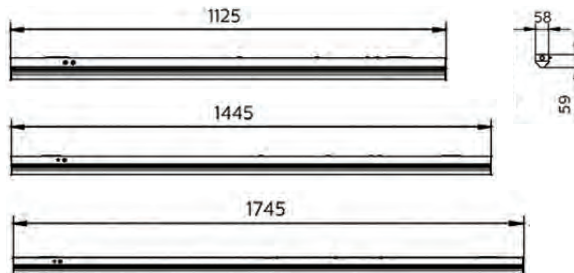

Order No.	Model No.	Description	Wattage (W)	Lumens (lm)	Efficacy (lm/W)	Colour Temp. (K)
LED BATTEN						
2501662942	911401810887	4ft Single	21	2500	120	4000K
2501662943	911401810987	4ft Twin	40	4800	120	4000K
2501662944	911401811087	5ft Single	29	3500	120	4000K
2501662946	911401811187	5ft Twin	50	6000	120	4000K
2501662947	911401811287	6ft Single	36	4300	120	4000K
2501662948	911401811387	6ft Twin	65	7800	120	4000K
2501607519	912401483459	Emergency Pack Manual Test				
2501607521	912401483460	Emergency Pack Self Test				

CCT & Power Switch LED Batten



5
YEAR
WARRANTY
35,000 Hours

IP20

CLASS
1

The Navara X3 Select LED Dual-Wattage & 3CCT battens are a simple and cost effective solution for a wide range of commercial and retail applications. 4ft, 5ft or 6ft versions available as dual wattage & 3CCT within each fitting. Available options include emergency, plug & play microwave sensor or microwave sensor corridor function, as well as batten mount PIR sensor. Push wire terminals & plug and play installation for the MW sensors to speed up the install and retro fit if required.



Material construction:

- Body: Powder coated mild steel
- Diffuser and end caps: Polycarbonate



Suitable for direct fix, trunking & conduit mounting



CCT & Wattage switchable



Push wire terminals for plug and play installation



Integrated emergency and dimmable variants available on request



Up to 144lm/w



62mm Wide



Order No.	Model No.	Description	Wattage (W)	Lumens (lm)	Efficacy (lm/W)	Colour Temp. (K)
CCT & POWER SWITCH LED BATTEN						
2501597944	KSR98300	4ft Single & Twin	20/38	2365-4960	Up to 134	3000/4000/6000K
2501597955	KSR98301	5ft Single & Twin	32/52	3685-6230	Up to 134	3000/4000/6000K
2501597966	KSR98302	6ft Single & Twin	40/60	4915-6955	Up to 134	3000/4000/6000K
2501597982	KSR98189	Emergency Pack - Standard & Self Test Selectable				
2501597977	KSR98195	Plug and Play On/Off Microwave Sensor				
2501245470	KSR8409	Batten Mount IP65 PIR Sensor				

Order by 5pm for next day delivery

REXEL

Denmans
REXEL GROUP

Linear Office Pendant





5
YEAR
WARRANTY

IP20

The new La Linea office pendant lighting range from KSR Lighting can either be suspended, using the supplied suspension kits, or they can be surface mounted. La Linea incorporates switchable technology allowing you to change the dual outputs of the fitting, as well as the colour temperature (3CCT - 3000K, 4000K, 6000K), all whilst on-site. La Linea also has an optional indirect mountable accessory module. The system can be easily connected to other fittings, with a range of optional X, L and T connectors, along with a bar to bar connector, supplied as standard.



 Material construction:
Body - Aluminium
Diffuser - Polycarbonate

 Plug-and-play with connector pieces for continuous effect lighting

 Can be surface mounted or suspended (1.75m suspension included)

 Dimming options available on request



Order No.	Model No.	Description	Wattage (W)	Colour Temp. (K)
LINEAR OFFICE PENDANT - LUMINAIRES				
2501608911	KSR98250	4ft Black	20/32	3000/4000/6000K
2503000330	KSR98250/EM	4ft Black Emergency	20/32	3000/4000/6000K
2501608912	KSR98251	4ft White	20/32	3000/4000/6000K
2503000331	KSR98251/EM	4ft White Emergency	20/32	3000/4000/6000K
2501608915	KSR98254	5ft Black	25/42	3000/4000/6000K
2503000332	KSR98254/EM	5ft Black Emergency	25/42	3000/4000/6000K
2501608916	KSR98255	5ft White	25/42	3000/4000/6000K
2503000333	KSR98255/EM	5ft White Emergency	25/42	3000/4000/6000K



Order No.	Model No.	Description	Wattage (W)	Colour Temp. (K)
LINEAR OFFICE PENDANT - BACK LIGHT KITS				
2501608913	KSR98252	4ft Back Lit Kit Black	2.5	3000/4000/6000K
2501608914	KSR98253	4ft Back Lit Kit White	2.5	3000/4000/6000K
2501608918	KSR98256	5ft Back Lit Kit Black	3	3000/4000/6000K
2501608919	KSR98257	5ft Back Lit Kit White	3	3000/4000/6000K

Order No.	Model No.	Description	Wattage (W)	Colour Temp. (K)
LINEAR OFFICE PENDANT - CONNECTOR ACCESSORIES				
2501608921	KSR98259	L-Connector Black	2	3000/4000/6000K
2501608922	KSR98260	L-Connector White	2	3000/4000/6000K
2501608923	KSR98261	T-Connector Black	2	3000/4000/6000K
2501608924	KSR98262	T-Connector White	2	3000/4000/6000K
2501608925	KSR98263	X-Connector Black	2	3000/4000/6000K
2501608926	KSR98264	X-Connector White	2	3000/4000/6000K

Order No.	Model No.	Description	Wattage (W)	Colour Temp. (K)
LINEAR OFFICE PENDANT - UGR LUMINAIRES				
2503031288	KSR98270	UGR 4ft Black	20/32	3000/4000/6000K
2503031289	KSR98270/EM	UGR 4ft Black Emergency	20/32	3000/4000/6000K
2503031295	KSR98271	UGR 4ft White	20/32	3000/4000/6000K
2503031296	KSR98271/EM	UGR 4ft White Emergency	20/32	3000/4000/6000K
2503031302	KSR98272	UGR 5ft Black	25/42	3000/4000/6000K
2503031303	KSR98272/EM	UGR 5ft Black Emergency	25/42	3000/4000/6000K
2503031308	KSR98273	UGR 5ft White	25/42	3000/4000/6000K
2503031309	KSR98273/EM	UGR 5ft White Emergency	25/42	3000/4000/6000K

Order No.	Model No.	Description	Wattage (W)	Colour Temp. (K)
LINEAR OFFICE PENDANT - UGR CONNECTOR ACCESSORIES				
2503031315	KSR98274	UGR L-Connector Black	2	3000/4000/6000K
2503031316	KSR98275	UGR L-Connector White	2	3000/4000/6000K
2503031317	KSR98276	UGR Black Reflector		
2503031318	KSR98277	UGR White Reflector		

Direct/Indirect LED Pendant



5
YEAR
WARRANTY
36,000 Hours

IP20

CLASS
1

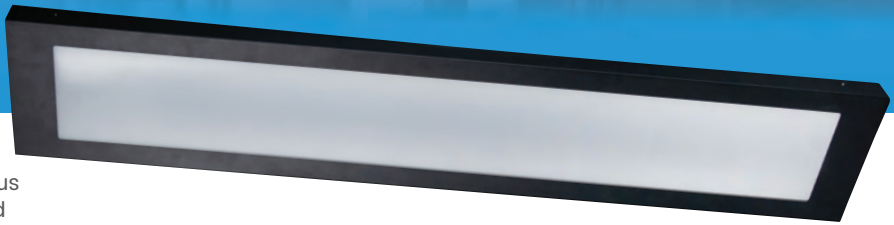

The new La Oficina Surface/Pendant fitting is perfect for office environments as well as numerous other applications. These can be surface mounted or suspended using the suspension kit supplied. When suspended, the design allows you to turn on the integrated backlight creating an indirect light. Also available as emergency which is non-self-test /self-test selectable.

- Material construction:
 Body - Aluminium
 Diffuser - Polycarbonate
- Three wattage and three colour selectable
- Up to 127lm/w
- Supplied with 1.5m suspension kit
- Switchable backlight for direct/indirect when suspension mounted

Order No.	Model No.	Description	Wattage (w)	Lumens (lm)	Emergency	Colour Temp. (K)
DIRECT/INDIRECT LED PENDANT						
2503031319	KSR98280	4ft Black	27/32/37	3335-4600		3000/4000/5000K
2503031320	KSR98280/EM	4ft Black	27/32/37	3335-4600	Yes	3000/4000/5000K
2503031321	KSR98281	4ft White	27/32/37	3335-4600		3000/4000/5000K
2503031322	KSR98281/EM	4ft White	27/32/37	3335-4600	Yes	3000/4000/5000K
2503031324	KSR98282	5ft Black	39/47/55	4760-6770		3000/4000/5000K
2503031325	KSR98282/EM	5ft Black	39/47/55	4760-6770	Yes	3000/4000/5000K
2503031326	KSR98283	5ft White	39/47/55	4760-6770		3000/4000/5000K
2503031327	KSR98283/EM	5ft White	39/47/55	4760-6770	Yes	3000/4000/5000K
2503031328	KSR98284	6ft Black	44/52/60	5585-7510		3000/4000/5000K
2503031329	KSR98284/EM	6ft Black	44/52/60	5585-7510	Yes	3000/4000/5000K
2503031330	KSR98285	6ft White	44/52/60	5585-7510		3000/4000/5000K
2503031331	KSR98285/EM	6ft White	44/52/60	5585-7510	Yes	3000/4000/5000K

IP44 Bulkhead







3
YEAR
WARRANTY
25,000 Hours

IP44

These IP44 luminaires provide excellent value for money and can be installed in any interior areas including staircases, bathrooms (zone 2) as well as sheltered external areas such as porches. The PMMA diffuser creates a soft light with a subtle halo effect.



-  Metal base with PMMA diffuser
-  Suitable for wall or ceiling mounting
-  CCT switchable

Order No.	Model No.	Description	Wattage (W)	Lumens (lm)	Colour Temp. (K)
IP44 BULKHEAD					
2450069489	ILBHE092	238mm Diameter	8	800	3000/4000/5000K
2450069490	ILBHE093	288mm Diameter	12	1200	3000/4000/5000K
2450069492	ILBHE095	338mm Diameter	16	1600	3000/4000/5000K
2450069491	ILBHE094	288mm Diameter with Microwave Sensor	12	1200	3000/4000/5000K
2503013165	ILBHE097	338mm Diameter Emergency	16	1600	3000/4000/5000K
2450069493	ILBHE096	338mm Diameter with Microwave Sensor	16	1600	3000/4000/5000K

Indoor Bulkhead – Colour & Wattage Selectable



A commercial and residential LED bulkhead luminaire ideal for new installations and retrofit applications in areas such as bathrooms, utility areas, student accommodation and hotels. Emergency and microwave sensor variants available.

Material Construction:
Base – Polycarbonate
Diffuser – Polycarbonate

Colour Temperature & Wattage selectable
3000K, 4000K, 6000K/10W, 14W, 20W

Push Fit Terminals for Easy Installation

Suitable for BESA Box Mounting

Comes with white bezel as standard

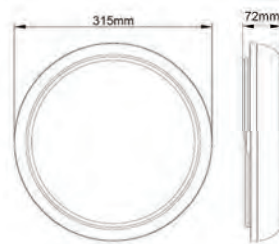

Shown with Chrome Rim

Order No.	Model No.	Description	Wattage (W)	CRI	Lumens (lm)	Colour Temp. (K)
INDOOR BULKHEAD – COLOUR & WATTAGE SELECTABLE						
2501401801	KSRSF400	Standard	10/14/20	85/87/84	1067-1962	3000/4000/6000K
2503031240	KSRSF395	Plug in Emergency Pack Standard & Self Test				
2503031238	KSRSF393	Plug in Microwave & Corridor Function Sensor				
2501401803	KSRSF401	Emergency				
2501401805	KSRSF403	Microwave Sensor + Emergency				

Order No.	Model No.	Description
ACCESSORIES		
2503015836	KSRSF411	Chrome Trim
2503031232	KSRSF338	Anti Ligature Housing Black
2503031233	KSRSF339	Anti Ligature Housing White

Mini Multi Bulkhead – Colour & Wattage Selectable



5
YEAR
WARRANTY
40,000 Hours

IP65

IK10

The Roma Mini Select surface fittings are the ultimate bulkhead solution, as standard fittings are triple CCT & multi wattage selectable.

- Material Construction:**
Base - Polycarbonate
Diffuser - Polycarbonate
- Colour Temperature & Wattage selectable**
3000K, 4000K, 6000K 8W, 12W
- Push Fit Terminals for Easy Installation**
- Suitable for BESA Box Mounting**
- Rear cable entry**
- 250mm wide, 85mm deep**



Order No.	Model No.	Description	Wattage (W)	Lumens (lm)	Emergency	Colour Temp. (K)
MINI MULTI BULKHEAD – COLOUR & WATTAGE SELECTABLE						
2501508499	KSRSF407	Standard	08-12	760/820/790 1050/1155/1155	No	3000/4000/6000K
2501508488	KSRSF408	Microwave Sensor	08-12	760/820/790 1050/1155/1155	No	3000/4000/6000K
2503000334	KSRSF409	Emergency	08-12	760/820/790 1050/1155/1155	Yes	3000/4000/6000K
2503000335	KSRSF410	Emergency Microwave Sensor	08-12	760/820/790 1050/1155/1155	Yes	3000/4000/6000K

XL Bulkhead – Colour & Wattage Selectable



5
YEAR
WARRANTY
40,000 Hours

IP65

IK10

The KSR Roma XL 5CCT & Multi Wattage fittings are a great addition to the already popular Roma range, these larger versions cover multiple outputs and colour temperatures & are the missing link to where more commercial outputs & sizes are required. Now also complete with conduit entry points and knockout points on the rims. Designed to match the other 2 sizes the Roma range can cover all your bulkhead requirements.

- Material construction
Base – Polycarbonate
Diffuser – Polycarbonate
- Wattage Selectable – 15W, 20W, 24W
- Colour Temperature & Wattage selectable
2700, 3000K, 4000K, 5000K & 6000K
- Suitable for BESA Box Mounting
- 400mm diameter



Order No.	Model No.	Description	Wattage (w)	Lumens (lm)	Colour Temp. (K)
XL BULKHEAD – COLOUR & WATTAGE SELECTABLE					
2503000336	KRSRF420	Roma XL Surface Bulkhead Standard	15/20/24	1690-2585	2700/3000/4000/5000/6000K
2503000337	KRSRF421	Roma XL Surface Bulkhead Emergency	15/20/24	1690-2585	2700/3000/4000/5000/6000K
2503000338	KRSRF422	Roma XL Surface Bulkhead Microwave Sensor	15/20/24	1690-2585	2700/3000/4000/5000/6000K
2503000339	KRSRF423	Roma XL Surface Bulkhead Emergency Microwave Sensor	15/20/24	1690-2585	2700/3000/4000/5000/6000K
2503000340	KRSRF424	Roma XL Surface Bulkhead Corridor Function	15/20/24	1690-2585	2700/3000/4000/5000/6000K
2503000341	KRSRF425	Roma XL Surface Bulkhead Emergency Corridor Function	15/20/24	1690-2585	2700/3000/4000/5000/6000K

Maxi Multi Bulkhead - CCT Selectable



3
YEAR
WARRANTY

IP54

The Maxima Dual CCT LED surface fittings are a Dual CCT surface mounted luminaire with an optional Halo effect rim attachment. Colour temperature selectable for 3000K or 4000K.



Material Construction:
Base - Polycarbonate
Diffuser - PMMA



Colour Temperature 3000K, 4000K



Rims Available - Lumen output will change with use of rim



Order No.	Model No.	Description	Diameter (mm)	Wattage (W)	Lumens (lm)	Colour Temp. (K)
MAXI MULTI BULKHEAD - CCT SELECTABLE						
2501370516	KRSRF355	Maxima M Bulkhead Standard	380	24	2110/2165	3000/4000K
2501370518	KRSRF356	Maxima M Bulkhead Emergency	380	24	2110/2165	3000/4000K
2501370520	KRSRF357	Maxima M Bulkhead Microwave Sensor	380	24	2110/2165	3000/4000K
2501370521	KRSRF358	Maxima M Bulkhead Microwave Sensor Emergency	380	24	2110/2165	3000/4000K
2501370522	KRSRF362	Maxima L Bulkhead Standard	485	30	2720/2775	3000/4000K
2501370523	KRSRF363	Maxima L Bulkhead Emergency	485	30	2720/2775	3000/4000K
2501370524	KRSRF364	Maxima L Bulkhead Microwave Sensor	485	30	2720/2775	3000/4000K
2501370525	KRSRF365	Maxima L Bulkhead Microwave Sensor Emergency	485	30	2720/2775	3000/4000K

Order No.	Model No.	Description	Diameter (mm)
ACCESSORIES			
2501370529	KRSRF359	Maxima M White Detachable Rim	380
2501370531	KRSRF360	Maxima M Chrome Detachable Rim	380
2501370532	KRSRF361	Maxima M Satin Chrome Detachable Rim	380
2501370533	KRSRF366	Maxima L White Detachable Rim	485
2501370534	KRSRF367	Maxima L Chrome Detachable Rim	485
2501370535	KRSRF368	Maxima L Satin Chrome Detachable Rim	485

Modular LED Bulkhead

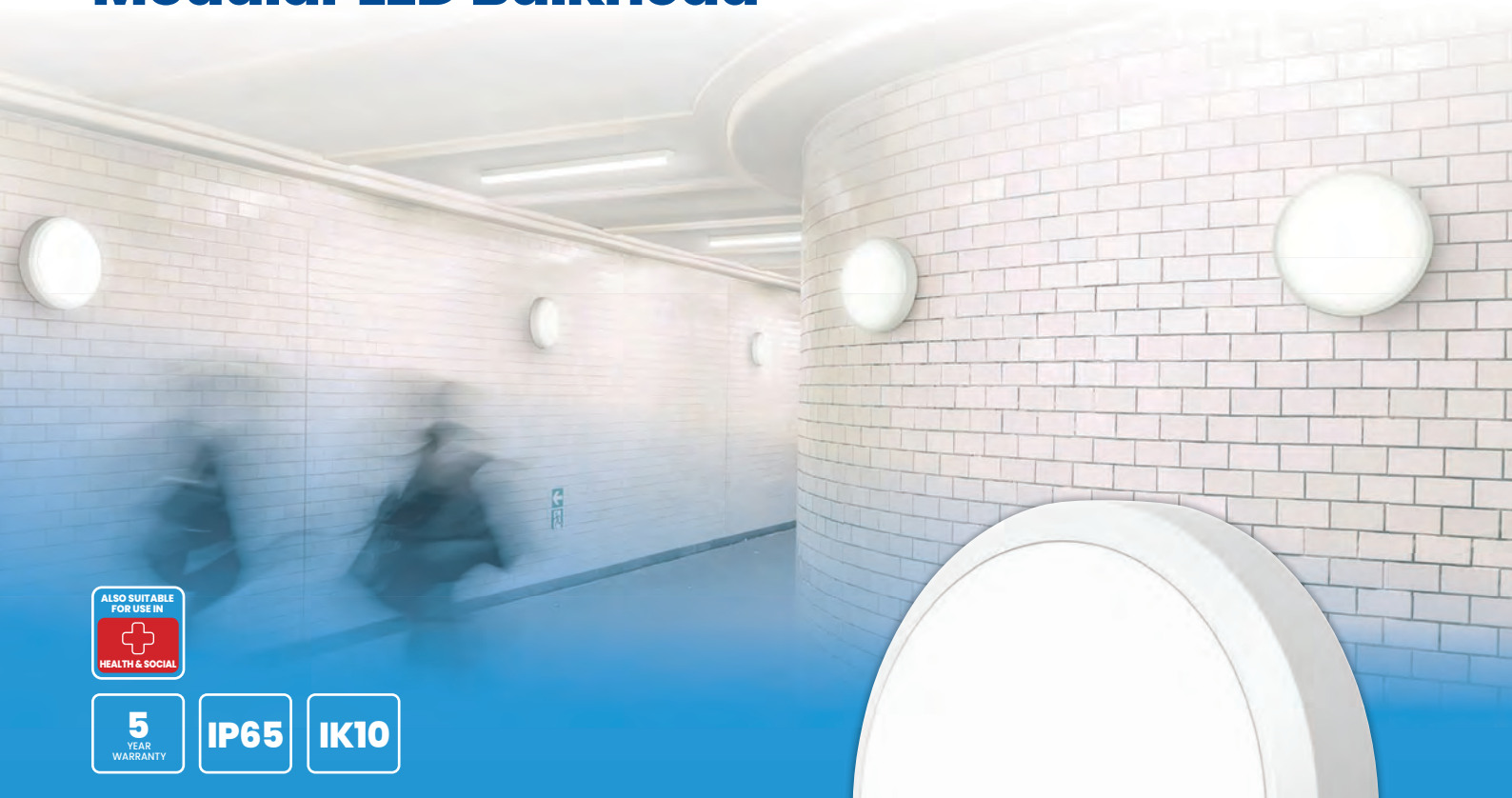

Ecolink Bulkhead is part of the Ecolink range offering high quality, reliable and lighting solutions for your projects. The Ecolink bulkhead is a truly versatile product offering many possibilities within 1 luminaire. The product comes with switchable wattage and CCT offering 4 different light outputs and 3 colour temperatures. Ease of installation is offered with 20mm side knockouts and Besa points at the back.

 Material Construction:
Body and diffuser: Polycarbonate

 120lm/w

 Plug in emergency and sensor options

 300mm diameter

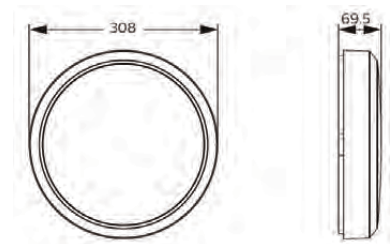

Order No.	Model No.	Description	Wattage (W)	Lumens (lm)	Colour Temp. (K)
MODULAR LED BULKHEAD					
2503016365	912401483593	10-16W 300mm LED Bulkhead	10-16	1200-2000	3000/4000/6500K

Order No.	Model No.	Description
ACCESSORIES		
2503016366	912401483594	Plug-In Microwave Sensor
2503016367	912401483595	Plug-In Emergency Pack (Manual & Self Test)
2503016371	912401483599	White Trim
2503016372	912401483601	Chrome Trim
2503016373	912401483608	Black Trim
2503016368	912401483596	Black Eyelid Trim
2503016369	912401483597	Black Eyelid Grille Trim
2503016370	912401483598	Black Grille Trim

02 | Office & Commercial Outdoor



Scan here to see our
full range online



Square LED Bulkhead – Colour & Wattage Selectable



5
YEAR WARRANTY
40,000 Hours

3
YEAR WARRANTY
Batteries

IP65

IK10

Material Construction:
Base - Polycarbonate
Diffuser - Polycarbonate

Multiple cable entries

255mm W x 255mm L x 100mm D

Class II

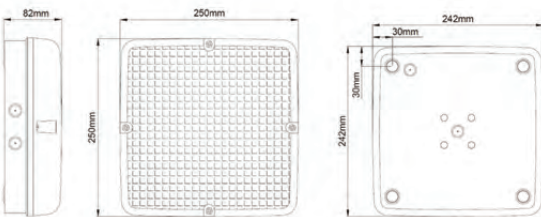

Order No.	Model No.	Description	Wattage (W)	Lumens (lm)	Colour	Colour Temp. (K)
SQUARE LED BULKHEAD - COLOUR & WATTAGE SELECTABLE						
2501597947	KRSRF340BLK/OP	Standard	9/14/18	1000/1500/1900	Black	3000/4000/6000K
2501597948	KRSRF340WHT/OP	Standard	9/14/18	1000/1500/1900	White	3000/4000/6000K
2501597949	KRSRF341BLK/OP	Emergency	9/14/18	1000/1500/1900	Black	3000/4000/6000K
2501597950	KRSRF341/ST/WH/OP	Self Test Emergency	9/14/18	1000/1500/1900	White	3000/4000/6000K
2501597951	KRSRF341WHT/OP	Emergency	9/14/18	1000/1500/1900	White	3000/4000/6000K
2501597952	KRSRF341/ST/BLK/OP	Self Test Emergency	9/14/18	1000/1500/1900	Black	3000/4000/6000K
2501597953	KRSRF342BLK/OP	Microwave Sensor	9/14/18	1000/1500/1900	Black	3000/4000/6000K
2501597954	KRSRF342WHT/OP	Microwave Sensor	9/14/18	1000/1500/1900	White	3000/4000/6000K
2501597956	KRSRF343BLK/OP	Microwave Sensor Emergency	9/14/18	1000/1500/1900	Black	3000/4000/6000K
2501597957	KRSRF343/ST/WHT/OP	Microwave Sensor Self Test Emergency	9/14/18	1000/1500/1900	White	3000/4000/6000K
2501597958	KRSRF343WHT/OP	Microwave Sensor Emergency	9/14/18	1000/1500/1900	White	3000/4000/6000K
2501597959	KRSRF343/ST/BLK/OP	Microwave Sensor Self Test Emergency	9/14/18	1000/1500/1900	Black	3000/4000/6000K
2501597960	KRSRF346BLK/OP	Photocell	9/14/18	1000/1500/1900	Black	3000/4000/6000K
2501597961	KRSRF346WHT/OP	Photocell	9/14/18	1000/1500/1900	White	3000/4000/6000K
2501597979	KRSRF347BLK/OP	Photocell Emergency	9/14/18	1000/1500/1900	Black	3000/4000/6000K
2501597980	KRSRF347WHT/OP	Photocell Emergency	9/14/18	1000/1500/1900	White	3000/4000/6000K

LED Wallpack



The Siena Select LED Wall Packs are dual wattage & 3CCT as standard. Available as standard, emergency, photocell & photocell with emergency, being IP65 & with an IK10 impact rating, this wall pack range can cover a vast range of installation requirements such as pathways, car parks & garages. They are also aesthetically pleasing with a slim design.

5
YEAR
WARRANTY
30,000 Hours

IP65

IK10



- Material Construction:
Polycarbonate body and diffuser
- Wattage and CCT switchable for maximum flexibility
- Ideal for coastal applications
- Side, rear and top cable entry options

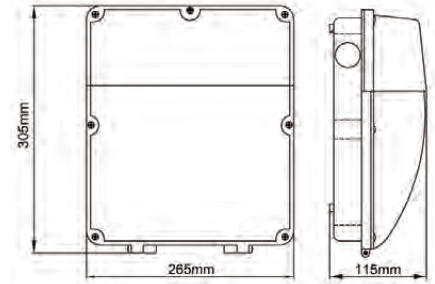

Order No.	Model No.	Description	Wattage (w)	Lumens (lm)	Colour Temp. (k)
LED WALLPACK					
2501586653	KSR1190BLK	Standard	18/30	1500-2475	3000/4000/6000K
2501586670	KSR1191BLK	Emergency	18/30	1500-2475	3000/4000/6000K
2501586681	KSR1192BLK	Photocell	18/30	1500-2475	3000/4000/6000K
2501586692	KSR1193BLK	Photocell Emergency	18/30	1500-2475	3000/4000/6000K

LED Polycarbonate Wallpack



LED bulkheads that are suitable for use with conduit installations that can be surface mounted or direct entry through the side/top knockouts.

- Material Construction:
Polycarbonate body - grey/black
Opal polycarbonate diffuser
- Multiple side and rear conduit entries for flexible installation
- Quick and easy speed fit terminals

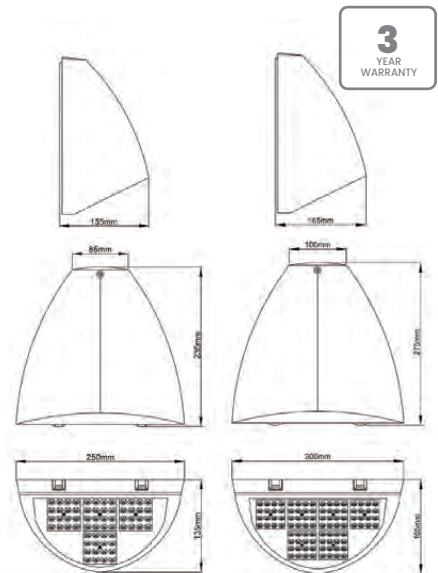

3
YEAR
WARRANTY

Order No.	Model No.	Description	Wattage (w)	Lumens (lm)	Colour Temp. (k)
LED POLYCARBONATE WALLPACK					
2503031345	KSR11102BLK	Standard	8/14	1125-1875	2700/3000/4000/6000K
2503031373	KSR11103BLK	Emergency	8/14	1125-1875	2700/3000/4000/6000K
2503031375	KSR11104BLK	Photocell	8/14	1125-1875	2700/3000/4000/6000K
2503031376	KSR11105BLK	Photocell Emergency	8/14	1125-1875	2700/3000/4000/6000K
2503031377	KSR11106BLK	Standard	16/20/24	2100-3195	2700/3000/4000/6000K
2503031378	KSR11107BLK	Emergency	16/20/24	2100-3195	2700/3000/4000/6000K
2503031379	KSR11108BLK	Photocell	16/20/24	2100-3195	2700/3000/4000/6000K
2503031381	KSR11109BLK	Photocell Emergency	16/20/24	2100-3195	2700/3000/4000/6000K



ILLUMINATING SAFER SITES

INTRODUCING OUR 110V SITIO RANGE

Take advantage of our free energy survey for your next project



**SITIO
ANTI-CORROSIVE**



**SITIO
TRIPOD & A-FRAME**



**SITIO
FESTOON KITS**



**SITIO
GLOBE LIGHT**



**SITIO
EM BULKHEAD**



**SITIO
EM TWIN SPOT**



**SITIO
DUAL VOLTAGE
BULKHEAD**



**SITIO
HANDHELD LIGHT**



**SITIO
RECHARGEABLE
FLOODLIGHT**



**SITIO
FLOODLIGHT**

LED Security & Conduit Bulkheads



LED bulkheads that are suitable for use with conduit installations that can be surface mounted or direct entry through the side/top knockouts.

3
YEAR
WARRANTY
30,000 Hours

IP65

IK08

CRI
80+

CLASS
2

- Material Construction:
Polycarbonate body - grey/black
Opal polycarbonate diffuser
- Multiple side and rear conduit entries for flexible installation
- Quick and easy speed fit terminals

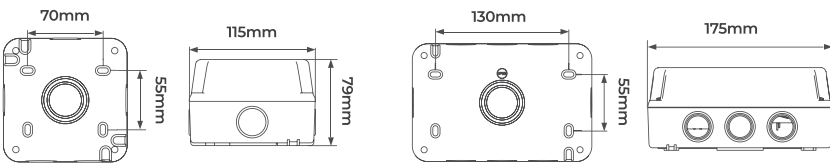

Order No.	Model No.	Description	Sensor	Wattage (W)	Lumens (lm)	Colour Temp. (K)
LED SECURITY & CONDUIT BULKHEADS						
2501120806	LBSIG4	LED Bulkhead Square Grey	-	4.5	400	4000K
2501120807	LBS2G8	LED Bulkhead Rectangular Grey	-	7	750	4000K
2501120808	LBS2G8MW	LED Bulkhead Rectangular Grey	Microwave Sensor	7.5	750	4000K

LED Die-Cast Aluminium Wallpack



A range of LED wall packs, boasting an IK10 rating, ideal for use in outdoor environments. Available in either Anthracite Grey or Light Grey finishes. All models include a CCT switch allowing the product to change colour temperature between Warm White 3000K Cool White 4000K and Daylight 6000K.

2
YEAR
WARRANTY

5
YEAR
WARRANTY
On-site

IP66

IK10

- Material Construction:
Body - Die Cast Aluminium
Diffuser - Polycarbonate
- CCT Switchable (3000/4000/6000K)
- Utilises Tridonic driver
- Also available in light grey finish (RAL7037) and DALI control options



Order No.	Model No.	Description	Efficacy (lm/W)	Wattage (W)	Lumens (lm)	Colour Temp. (K)
LED DIE-CAST ALUMINIUM WALLPACK						
2501464552	OV207IAG15	Standard	110-130	15	1650-1950	3000/4000/6000K
2501464553	OV207IAG15EM	Emergency	110-130	15	1650-1950	3000/4000/6000K
2501464555	OV207IAG15PC	Photocell	110-130	15	1650-1950	3000/4000/6000K
2501464554	OV207IAG15EMPC	Photocell Emergency	110-130	15	1650-1950	3000/4000/6000K
2501464556	OV207IAG25	Standard	100-120	25	2500-3000	3000/4000/6000K
2501464557	OV207IAG25EM	Emergency	100-120	25	2500-3000	3000/4000/6000K
2501464559	OV207IAG25PC	Photocell	100-120	25	2500-3000	3000/4000/6000K
2501464558	OV207IAG25EMPC	Photocell Emergency	100-120	25	2500-3000	3000/4000/6000K

03 | Education



Scan here to see our
full range online



CCT Switchable LED Panels



The Recessed Starlet Select Backlit LED Panels design makes them ideal for commercial applications, with its high quality TP(a) rated diffuser & newly improved Lumen outputs, the panel can be used throughout the install without restriction, along with the convenience of being able to switch between 2 wattages & selectable CCT. Available as 3 different sizes with optional suspension or surface frames, making them extremely versatile panels for all applications.

- Backlit for maximum efficiency
- Plug & Play driver
- Dimming options available on request
- Surface mount frames available



Order No.	Model No.	Description	Wattage (w)	Lumens (lm)	Colour Temp. (K)
CCT SWITCHABLE LED PANELS					
2501431082	KSR98150	TP(a) 600x600 Standard	25/36	2910-4275	3000K/4000K/6000K
2501431054	KSR98150/EM	TP(a) 600x600 Emergency	25/36	2910-4275	3000K/4000K/6000K
2501431055	KSR98151	TP(a) 1200x300 Standard	25/36	2910-4275	3000K/4000K/6000K
2501431057	KSR98152	TP(a) 1200x600 Standard	40/58W	4705-6890	3000K/4000K/6000K

LED Panel (Backlit)



ALSO SUITABLE FOR USE IN

- OFFICE
- HEALTH & SOCIAL

7 YEAR WARRANTY
70,000 Hours

IP44

DESIGNER SELECTION

Backlit LED panels mount the modules to the back of the panel's body, allowing direct downward distribution from the modules themselves. Due to the direct light, there is no requirement for an LGP. This allows a backlit panel to offer increased performance in terms of lumen per watt and balanced light distribution.



- Backlit LED Panel with slimline 30mm depth finished in RAL9016 white
- Plug and play ENEC approved loop in-out driver with power change dip switch
- 600x600mm white aluminium frame
- Recessed mounted suitable for use in 15mm or 24mm standard exposed ceiling grids
- Rear safety wire suspension points as standard
- DALI and Wireless Controls available on request

Order No.	Model No.	Description	Wattage (W)	Lumens (lm)	Efficacy (lm/W)	Colour Temp. (K)
LED PANEL (BACKLIT)						
2503031175	LBX66WHS40-05	TP(α) 600x600 LED Panel UGR19	22/27	3500/4200	159	4000K
2503049280	LBX612WS40-05	TP(α) 1200x600 LED Panel UGR19	22/27	4250/5000	157	4000K
2503046865	LED3EPI004W-01	Emergency Kit				

LED Panel (Backlit) High Efficiency



STERLING PRO uses the latest backlit LED technology, mounted in a slim (34mm), white painted rigid steel body.

- Backlit design enables high efficiency of up to 188 lumens per circuit watt
- Supplied with multi wattage selectable driver
- 3000K and 6000K colour temperatures also available
- Corridor function available on request
- Available in 1200x300 and 1200x600 sizes on request





Order No.	Model No.	Description	Wattage (W)	Lumens (lm)	Efficacy (lm/W)	Colour Temp. (K)
LED PANEL (BACKLIT) HIGH EFFICIENCY						
2503039949	NST17-28/UGR/66/840	TP(α) 600x600 LED Panel UGR<19	17-28	3129-4949	181	4000K
2503039952	NST17-28/UGR/66/940	TP(α) 600x600 LED Panel UGR<19 CRI90	17-28	2926-4613	166	4000K
2503039936	NST11-28/UGR/66/DD/840	TP(α) 600x600 LED Panel UGR<19 DALI Dimmable	11-28	1928-4949	181	4000K
2503039938	NST11-28/UGR/66/DD/940	TP(α) 600x600 LED Panel UGR<19 CRI90 DALI Dimmable	11-28	1754-4613	166	4000K
2501157624	N/REC/M3/PACK/V2	Remote Emergency Pack LiFeP04				
2501376522	N/REC/STM3/PACK/V2	Remote Self-Test Emergency Pack LiFeP04				
2503039921	NST/PRO/SMK/66	Surface Mount Kit for 600x600				
2503049281	NST/PRO/WSK/66-123	Suspension Kit 1.5m for 600x600				

Low Glare LED Surface Linear

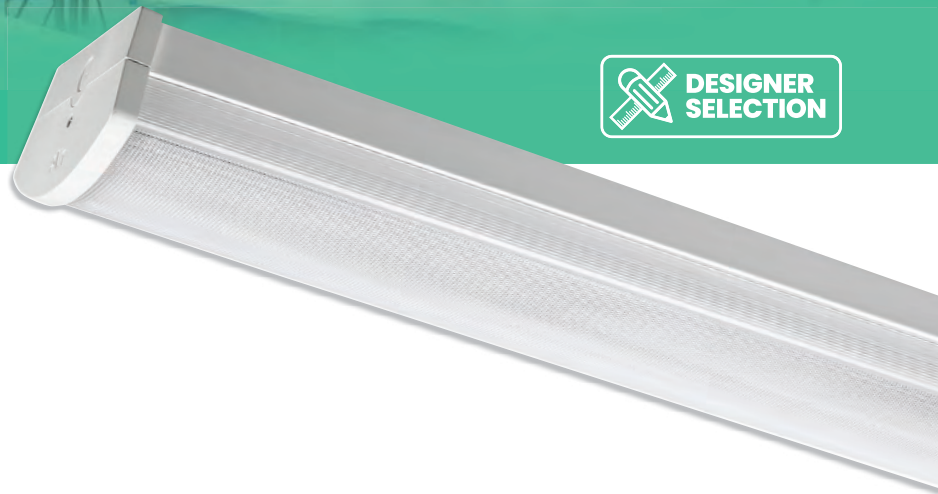

The Yale Pro is a robust luminaire and benefits from UGR<19 low glare, which is particularly useful in schools, colleges, classrooms and office environments, where better glare control is required. Complete with IP40 and IK10 ratings, Yale Pro is ideal for use in corridors, circulation areas and communal spaces including areas of leisure and increased physical activity.



-  Material Construction
 - Steel and polycarbonate body
 - Polycarbonate diffuser
-  Low glare - UGR<19 (Unified Glare Rating)
-  Wattage selectable for four different outputs
-  Dimming and Smart controls available on request
-  Lithium LiFePO4 Emergency

Order No.	Model No.	Description	Wattage (W)	Lumens (lm)	Emergency	Colour Temp. (K)
LOW GLARE LED SURFACE LINEAR						
2501628714	NYA/4/20-37/840	4ft LED Standard	20/25/30/35	2600, 3244, 3861, 4455	-	4000K
2501628715	NYA/4/20-37/M3L/840	4ft LED Emergency	20/25/30/35	2600, 3244, 3861, 4455	Yes	4000K
2501628716	NYA/5/27-44/840	5ft LED Standard	27/33/37/43	3675, 4401, 5134, 5710	-	4000K
2501628717	NYA/5/27-44/M3L/840	5ft LED Emergency	27/33/37/43	3675, 4401, 5134, 5710	Yes	4000K
2501628719	NYA/6/36-58/840	6ft LED Standard	37/46/48/58	5078, 6211, 6511, 7648	-	4000K
2501628720	NYA/6/36-58/M3L/840	6ft LED Emergency	37/46/48/58	5078, 6211, 6511, 7648	Yes	4000K

Order by 5pm for next day delivery



EDUCATION PROJECTS? A DAY AT SCHOOL. COVERED.



From classrooms and laboratories to dining spaces, sports facilities, external environments and emergency lighting solutions, NVC delivers complete lighting solutions for every space across the education estate.



8.45 ARRIVE AT SCHOOL

Bollards, wall lights, post-top lanterns and street lighting for safe, welcoming entrances and exterior spaces.



9.00 MORNING LESSONS

Low-glare LED panels, linear lighting and lighting controls designed for focus, concentration and learning.



11.00 PRACTICAL LEARNING

High-performance panels, linear luminaires and specialist lighting solutions for laboratories, ICT suites and practical teaching spaces.



12.30 LUNCH TIME

Decorative lighting, downlights and suspended luminaires creating welcoming dining and social environments.



14.00 SPORTS & ACTIVITIES

Sports hall lighting, high bays and floodlights delivering performance for sport, play and wellbeing.



15.30 END OF SCHOOL

Emergency lighting, exit signage and exterior lighting solutions supporting safe departures and secure school environments.



SCAN TO EXPLORE
THE FULL **NVC LIGHTING**
RANGE FOR EDUCATION



**TRUSTED
LIGHTING
SOLUTIONS
FOR THE
FULL PROJECT**



QUALITY AND
PERFORMANCE



PROJECT
SUPPORT



PROe RANGE
OF PRODUCTS



FULL Life
EMERGENCY
RANGE



INDUSTRY LEADING,
NO-NONSENSE
WARRANTY



UK STOCKHOLDING
& FAST DELIVERY



SUSTAINABILITY
FOCUSED

04 | Health & Social Care



Scan here to see our
full range online







LED Panel – IP65



Backlit LED panels mount the modules to the back of the panel's body, allowing direct downward distribution from the modules themselves. Due to the direct light, there is no requirement for an LGP. This allows a backlit panel to offer increased performance in terms of lumen per watt and balanced light distribution.



-  Material Construction:
Body - Aluminium
-  Plug and play ENEC approved
loop in-out driver
-  Wattage switchable
-  CRI>90

Order No.	Model No.	Description	Wattage (W)	Lumens (lm)	Efficacy (lm/W)	Colour Temp. (K)
LED PANEL – IP65						
2503027213	LBX66IPHS40-05	TP(α) IP65 LED Panel	27/33	3500/4200	130	4000K
2503046865	LED3EP1004W-01	Emergency Kit				

NatureConnect brings daylight into dark areas



Discover NatureConnect

NatureConnect skylights are indistinguishable from a real window by providing a daylight effect and a view to the sky, increasing the feeling of spaciousness. The blue sky mimics daylight and elevates performances of people due to the melanopic light boost. At the same time, it offers functional lighting.

Highlights of the NatureConnect Skylight

- Best retrofit daylight experience
- Easy installation on the grid ceiling
- The blue sky mimicking a view the sky
- Biophilic melanopic lighting
- Functional lighting, meeting UGR 19
- Adapt the scenes with a single touch



NatureConnect
by @ignify

Scan the QR code to learn more about NatureConnect:



LED Bulkhead

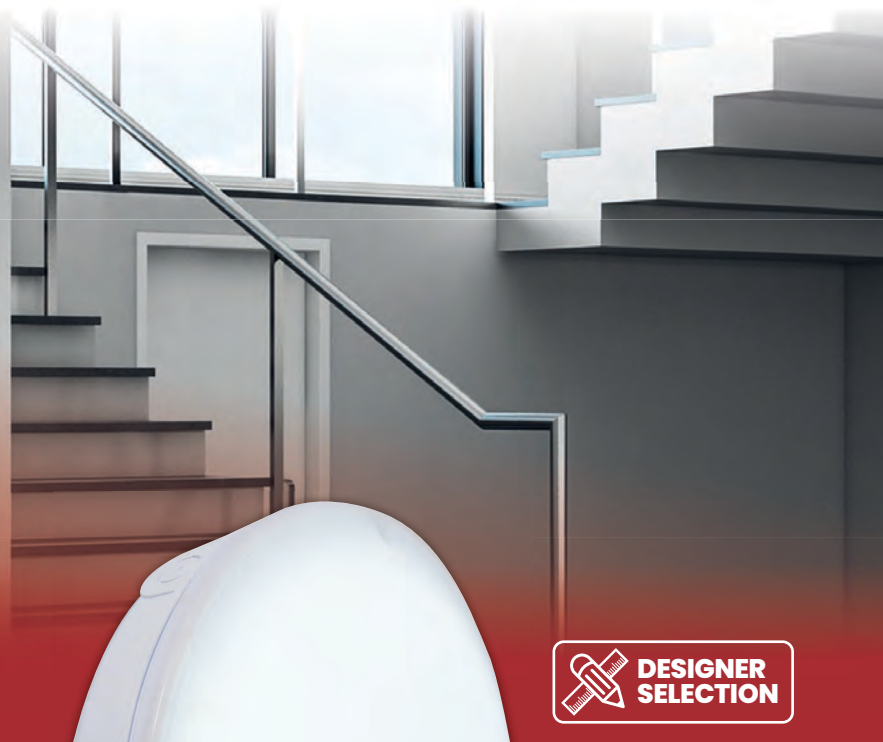

A commercial LED bulkhead luminaire ideal for new installations and retrofit applications in areas such as entrances, corridors, stairwells and other commercial areas. A range of accessories allow for a more decorative look yet maintaining its robust performance. Black and white rim options available in plain or eyelid styles.

Material Construction:
 Base - Polycarbonate
 Diffuser - Polycarbonate
 Rim - ABS

Colour Temperature & Wattage selectable
 3000K, 4000K, 6000K 10W, 14W, 20W

Push fit terminals for easy installation

Suitable for BESA Box Mounting

Multiple cable entries (side or rear) and suitable for Beza Bix mounting

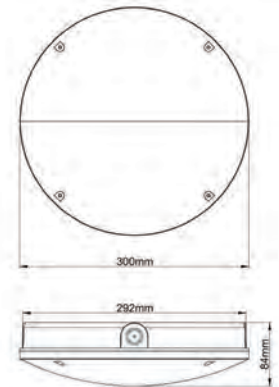

Order No.	Model No.	Description	Wattage (W)	Lumens (lm)	Colour Temp. (K)
OUTDOOR BULKHEAD - COLOUR & WATTAGE SELECTABLE					
2501401812	KSRSF330	Standard	9/14/18	1145-2126	2700/3000/4000/5000/6000K
2501401814	KSRSF331	Emergency	9/14/18	1145-2126	2700/3000/4000/5000/6000K
2501401815	KSRSF332	Microwave Sensor	9/14/18	1145-2126	2700/3000/4000/5000/6000K
2501401816	KSRSF333	Microwave Sensor Emergency	9/14/18	1145-2126	2700/3000/4000/5000/6000K

Order No.	Model No.	Description
ACCESSORIES		
2501401824	KSRSF323	Plain Rim Matte Black
2501401823	KSRSF324	Plain Rim Matte White
2501401826	KSRSF325	Eyelid Rim Matte Black
2501401825	KSRSF326	Eyelid Rim Matte White

LED Residential Decorative Bulkhead



3
YEAR
WARRANTY
30,000 Hours

IP54

CRI
80+

An LED bulkhead, ideal for bathrooms, utility and decorative installations. Easy installation with interchangeable twist on/off white and polished chrome bezels for classic or decorative finishes.



- Material Construction:**
Polycarbonate body
Opal polycarbonate diffuser
- Wall and ceiling mountable**
- Push fit connector for quick and easy installation**
- Supplied with interchangeable white and polished chrome trims**

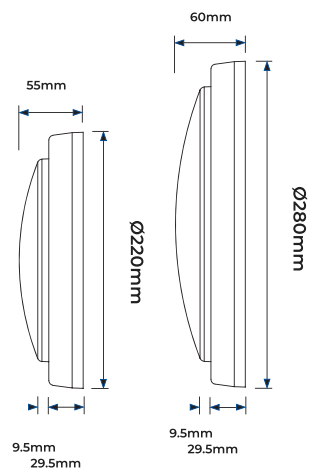

Order No.	Model No.	Description	Wattage (W)	Lumens (lm)	Efficacy (lm/W)	Colour Temp. (K)
LED RESIDENTIAL DECORATIVE BULKHEAD						
2501003718	EBH22S40	Residential Decorative Bulkhead 220mm	14	1300	93	4000K
2501182969	EBH28S40	Residential Decorative Bulkhead 280mm	17	1650	97	4000K

IP65 LED Downlight



5
YEAR
WARRANTY

2
YEAR
WARRANTY
On-Site

IP65

The Faceta LED Commercial Downlight range are retrofit LED lighting for widely used 6" and 8" fluorescent downlights with a distinctive faceted white reflector and a recessed light source.

- Unique white faceted reflector
- High efficiency up to 150lm/W
- DALI, 1-10V, PUSH dimming and Casambi control options available on request
- Wattage and CCT switchable
- Flicker free
- 90° beam angle



Order No.	Model No.	Description	Wattage (W)	Lumens (lm)	Colour Temp. (K)
IP65 LED DOWNLIGHT					
2503042027	FAC26IN16-SCT	164mm Cutout	10/13/16	1400-2240	3000/4000/5000K
2503042028	FAC28IN20-SCT	205mm Cutout	14/17/20	1960-2800	3000/4000/5000K
2503029973	UEM03/SST	Emergency Conversion (Manual & Self Test)			
2503042025	FAC2AG-CLR	Clear Glass Drop-Glass Attachment for 205mm Cutout			
2503042026	FAC2AG-OPL	Opal Glass Drop-Glass Attachment for 205mm Cutout			

Retrofit LED Gear Tray



Universal LED retrofit gear tray for replacing now discontinued fluorescent 2D lamps and control gear.



- Multiple mounting points for retrofit into existing bulkhead housings
- Plug and Play emergency packs and sensors

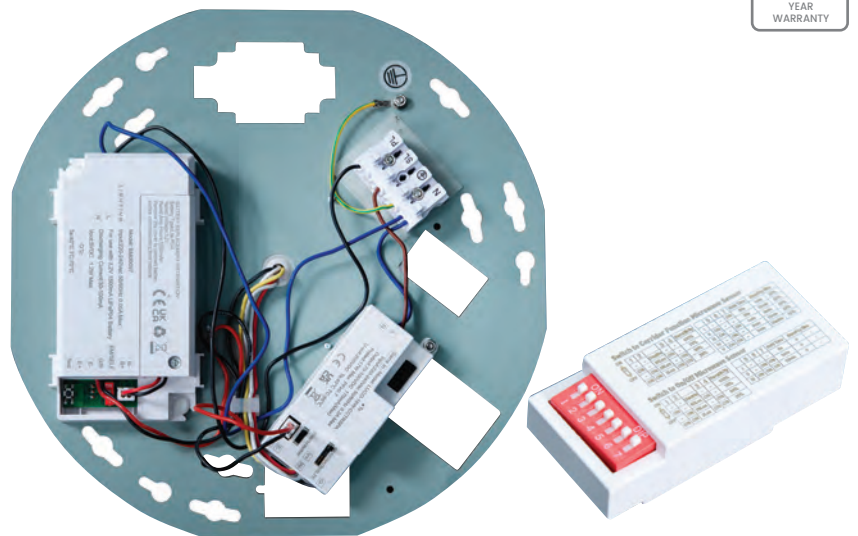
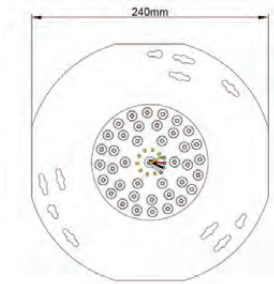

Order No.	Model No.	Description
RETROFIT LED GEAR TRAY		
2503031234	KSRSF390	Retrofit Gear Tray
2503031238	KSRSF393	Plug in Microwave & Corridor Function Sensor
2503031240	KSRSF395	Plug in Emergency Pack Standard & Self Test

05 | Retail & Hospitality

Scan here to see our
full range online



LED Wall Washer



A recessed wall washer designed for retail the Luceco Wall Washer benefits from die-cast aluminium construction. With lockable adjustable and a multifaceted reflector, the Wall Washer is a flexible solution.

- Die-cast aluminium body
- Suitable replacements for 35w and 70w CDM-T fittings
- Lockable adjustability and multifaceted reflector

Please note:

Only available on back to back orders



Order No.	Model No.	Description	Wattage (w)	Lumens (lm)	Cut out (mm)	Colour Temp. (K)
LED WALL WASHER						
2500970672	LWCW20S40-01	Fixed Output LED Wall Washer	22	1900	145	4000K
2500970673	LWCW34S40-01	Fixed Output LED Wall Washer	38	3200	170	4000K

Adjustable Downlight







3
YEAR
WARRANTY
54,000 Hours

IP20



Introducing the KSR Lighting Avio Adjustable Downlight Range. Choose from two sizes which can be surface mounted or recessed. The KSR97196 covers cut outs ranging from 65mm to 160mm and select from a range of wattage options - 10W, 15W or 18W, while the KSR97197 series covers dimensions from 65mm to 240mm and select from a range of wattage options - 15W, 22W or 24W, both versions are equipped with selectable 3CCT so you can effortlessly adjust the colour temperature of the light to suit your mood or environment.

-  Aluminium body construction
-  Adjustable to cover a range of cutout sizes
-  Selectable wattage and colour temperature
-  Emergency variants available on request

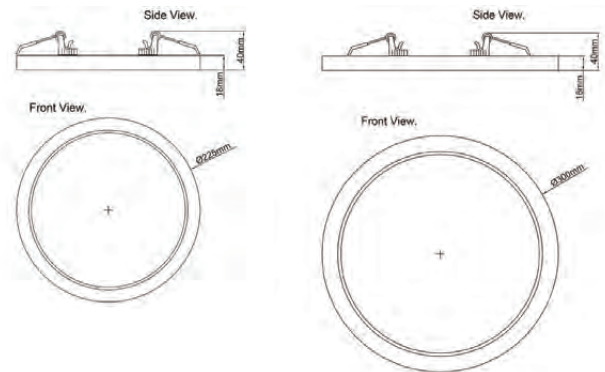

Order No.	Model No.	Description	Wattage (W)	Cut out (mm)	Lumens (lm)	Colour Temp. (K)
ADJUSTABLE DOWNLIGHT						
2503006628	KSR97196	Adjustable Downlight 65-160mm Cutout	10/15/18	65-160	720-1435	2700/3000/4000K
2503006630	KSR97197	Adjustable Downlight 65-240mm Cutout	15/22/24	65-240	1300-2115	2700/3000/4000K
2503006631	KSR97198	Black Bezel to Suit KSR97196				
2503006632	KSR97199	Black Bezel to Suit KSR97197				

3 Circuit Track & Accessories



A range for hospitality, retail & residential environments. Multiple track, fittings & accessories for adaptability.

- Three circuit track
- Black and white options available
- Full lighting designs available on request
- Back to back ordering, delivery within 3-7 days

Order No.	Model No.	Description
3 CIRCUIT TRACK		
2500605262	KSR6400BLK	Escala 3 Circuit 1m Track Black
2500605263	KSR6400WH	Escala 3 Circuit 1m Track White
2500605264	KSR6401BLK	Escala 3 Circuit 2m Track Black
2500605265	KSR6401WH	Escala 3 Circuit 2m Track White
3 CIRCUIT TRACK ACCESSORIES		
2500605268	KSR6403BLK	Escala 3 Circuit Right Sided Live End Black
2500605269	KSR6403WH	Escala 3 Circuit Right Sided Live End White
2500605270	KSR6404BLK	Escala 3 Circuit Left Sided Live End Black
2500605271	KSR6404WH	Escala 3 Circuit Left Sided Live End White
2500605272	KSR6405BLK	Escala 3 Circuit Mini Connector Black
2500605273	KSR6405WH	Escala 3 Circuit Mini Connector White
2500605274	KSR6406BLK	Escala 3 Circuit I Connector Black
2500605275	KSR6406WH	Escala 3 Circuit I Connector White
2500605276	KSR6407BLK	Escala 3 Circuit Right Sided L Connector Black
2500605277	KSR6407WH	Escala 3 Circuit Right Sided L Connector White
2500605278	KSR6408BLK	Escala 3 Circuit Left Sided L Connector Black
2500605279	KSR6408WH	Escala 3 Circuit Left Sided L Connector White
2500605280	KSR6409BLK	Escala 3 Circuit Right Sided T Connector Black
2500605281	KSR6409WH	Escala 3 Circuit Right Sided T Connector White
2500605282	KSR6410BLK	Escala 3 Circuit Left Sided T Connector Black
2500605283	KSR6410WH	Escala 3 Circuit Left Sided T Connector White
2500605284	KSR6411BLK	Escala 3 Circuit Flexible Connector Black
2500605285	KSR6411WH	Escala 3 Circuit Flexible Connector White
2500605286	KSR6412BLK	Escala 3 Circuit Dead End Black
2500605287	KSR6412WH	Escala 3 Circuit Dead End White
3 CIRCUIT TRACK SUSPENSION KITS		
2500605288	KSR6413BLK	Escala 3 Circuit 1.5 Metre Wire Suspension Kit Black
2500605289	KSR6413WH	Escala 3 Circuit 1.5 Metre Wire Suspension Kit White

3 Circuit Track Lights



A range for hospitality, retail & residential environments. Multiple track, fittings & accessories for adaptability.

Black and white options available

Full lighting designs available on request



Order No.	Model No.	Description	Colour	Wattage (W)	Lumens (lm)	Colour Temperature (K)
3 CIRCUIT TRACK LIGHTS						
2503031364	KSR6470BLK	Rosco GU10 Track Fitting	Black			
2503031367	KSR6470WH	Rosco GU10 Track Fitting	White			
2503031368	KSR6471BLK	Rosco LED Adjustable Beam 15-55° Track Fitting	Black	10	660-830	2700/3000/4000K
2503031369	KSR6471WH	Rosco LED Adjustable Beam 15-55° Track Fitting	White	10	660-830	2700/3000/4000K
2503031370	KSR6472BLK	Rosco Multi Wattage LED Track Fitting	Black	16/20/24	1370-2085	2700/3000/4000K
2503031371	KSR6472WH	Rosco Multi Wattage LED Track Fitting	White	16/20/24	1370-2085	2700/3000/4000K
2503031372	KSR6473BLK	Rosco Multi Wattage LED Track Fitting	Black	28/32/36	2145-3095	2700/3000/4000K
2503031374	KSR6473WH	Rosco Multi Wattage LED Track Fitting	White	28/32/36	2145-3095	2700/3000/4000K

**CHOOSE
LITHIUM BATTERY
CHOOSE
7-YEAR WARRANTY
CHOOSE
THE BEST OPTION
CHOOSE
LiFe**

LiFe. A range of emergency lighting from NVC all powered by the latest lithium iron phosphate (LiFePO₄) battery technology. The brighter choice for your business. The brighter choice for your customer.

To find out more about NVC Lighting's LiFe emergency range, scan the QR code or visit: nvc-choose-life.com



T: 0121 457 6340
E: sales@nvcuk.com
W: www.nvcuk.com



06 | Emergency



Scan here to see our
full range online



LED Emergency Lighting

Emergency lighting is primarily intended to provide sufficient illumination to enable people to navigate their way safely out of a building in case of an emergency. Legislation now demands that the person responsible for the building ensures compliance with the standards and carries severe penalties if not adhered to.

Key parts of the Fire Safety Order Directive: 2005 are:

- The responsible person has a duty to take general fire precautions
- The responsible person must complete a risk assessment
- The responsible person must make fire safety arrangements

BS5266 – Emergency Lighting, the code of practice for the emergency lighting of premises

BS 5266 specifies the requirement for emergency lighting with specific lighting levels in areas of high risk, as follows:

- Kitchens
- First aid rooms
- Treatment rooms
- Refuges
- Plant, switch and winding rooms
- Fire alarm control indication equipment
- Reception areas
- Panic bars/pads
- Swimming pool surrounds and diving areas

BS 5266 specifies that luminaires are positioned:

- Along escape routes
- At every change in direction
- Adjacent to any step or trip hazard
- Over every flight of stairs so each step receives direct light
- Close to fire fighting equipment and call points
- Outside every final exit

Open area (Symmetric – 0.5 Lux)

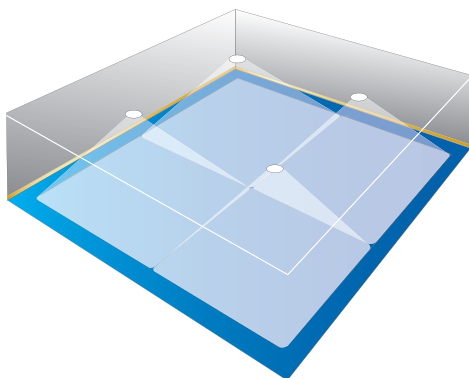

Escape Route (Asymmetric – 1 Lux)

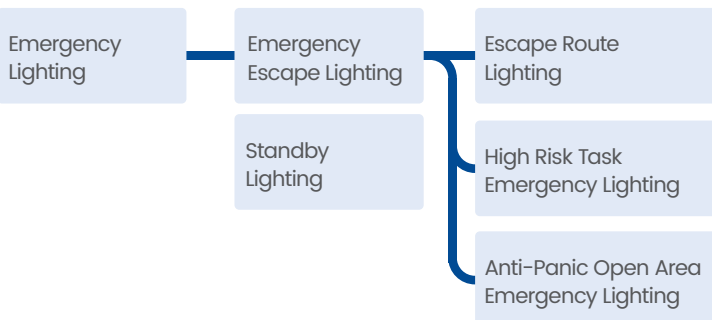
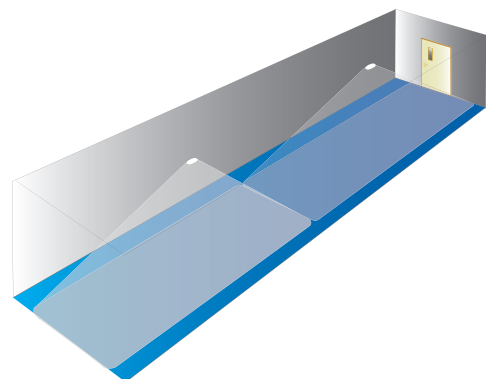

This is the most likely to be used in the event of a fire. It is necessary to allow evacuation of a building as rapidly as possible.

In hazardous areas where dangerous processes or situations need to be properly monitored, it is essential that emergency lighting systems are designed to meet the specific needs of the environment.

To avoid panic in large open areas, emergency lighting must enable people to move safely to the nearest suitable designated escape route.

LED is now the preferred light source for all emergency lighting

LOWER MAINTENANCE COSTS

With old fluorescent and incandescent technologies lamps had to be changed regularly. The long life of LEDs means that this is no longer necessary, so maintenance cost are greatly reduced.

RELIABILITY

Fluorescent lamps were never ideally suited to being run on batteries, so blackened lamp ends were a common problem indicating that a lamp was nearing the end of its life. LEDs are well suited to running on battery power and are therefore much more reliable.

BETTER LIGHT DISTRIBUTION

Fitted with a lens, LEDs can give the precise light distribution needed for corridors.

Better light distribution means improved uniformity, better spacing and fewer fittings required to give an installation that conforms to standards.

There are only two types of exit sign legends that comply with current legislation

EUROPEAN SAFETY SIGNS DIRECTIVE

The European Safety Signs Directive calls for the following legends, which are sometimes also referred to as "Euro legends" or "man running towards door". This is the style of legend supplied as standard with Newlec emergency fittings.

There are three Euro legends in use:



"Exit to the left"



"Exit straight ahead"



"Exit to the right"

The European Safety Signs Directive is not explicit concerning the use of either an up or down-arrow to indicate "straight ahead". Both are acceptable, but we supply the arrow-down legend as standard.

Euro legends are generally used in existing installations where the format is already installed.

ISO7010 & BS5266

These two standards both use a single set of legends, sometimes referred to as "ISO7010" or "man running through door" legends. These legends are available as optional extras with Newlec emergency fittings.

There are three ISO7010 legends in use:



"Exit to the left"



"Exit straight ahead"



"Exit to the right"

Note that ISO7010 and BS5266 are explicit that "straight ahead" is to be indicated with an up-arrow.

ISO7010 legends are generally used for all new installations.

Please note: Although both legend types are in use, only one type can be used in any one installation.

LED Emergency Bulkhead



The new Newlec bulkhead uses up-to-date Lithium LiFePO4 battery technology for long battery life. It is a slim multi-purpose IP65 rated LED emergency bulkhead suitable for use on corridors, exits and escape routes. A range of attachments and legends enable the bulkhead to also be used as an exit sign or double sided exit sign.

- Supplied complete with Euro legend kit (man running towards door) to enable use as an exit sign
- Lithium Iron Phosphate Battery (LiFePO4)
- 20m maximum viewing distance with standard legends
- Drop down attachment (DDA) supplied with Euro legend kit to enable use as a double sided exit sign
- 30m maximum viewing distance with drop down attachment (DDA).
- Can be installed in maintained or non-maintained mode (based on wiring) for flexibility
- ISO 7010 / BS 5266 legends (man running through door) are available separately.
- 3 hour operation on battery power after mains failure
- Supplied with Euro legend as standard. ISO legends available separately, please refer to pages 56-57 for differences between legend types



Order No.	Model No.	Description
LED EMERGENCY BULKHEAD		
2501673128	NLE3B-LI	Emergency Bulkhead

Order No.	Model No.	Description
ACCESSORIES		
1051088377	NLE3BISOL	ISO7010 Legend Kit
1051088378	NLE3BRMK	Recessed Mounting Kit
1051088379	NLE3BDDA	Drop Down Attachment for NLE3B

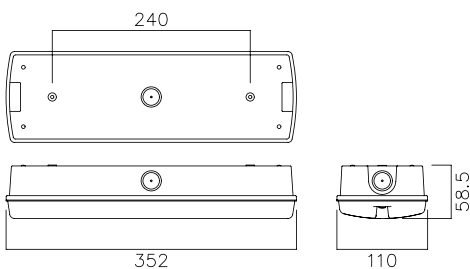

LED Emergency Bulkhead



Ecolink Emergency Bulkhead is part of the Ecolink Emergency standalone range offering reliable and robust emergency solutions for your projects. The emergency bulkhead luminaire offers a robust solution with ribbed, UV stabilized construction and IP65 protection. The product can be used as both maintained and non-maintained.



- Dual test as standard
- Supplied complete with self adhesive ISO legends
- LiFePO4 battery technology

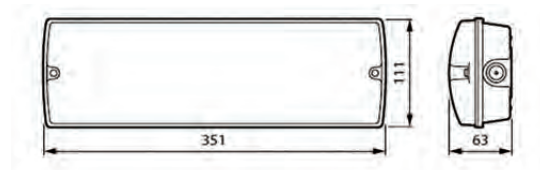

Order No.	Model No.	Description	Wattage (W)	Lumens (lm)	Colour Temp. (K)
LED EMERGENCY BULKHEAD					
2503040070	912401483645	LED Emergency Bulkhead	3	150	6500

Nebraska Life



IP65 LED slim emergency bulkhead, gear tray fixed to diffuser for easy access, mains connection block for loop in / loop out.



- Polycarbonate base and cover
- Supplied with either Euro legend pack or ISO legend pack
- 20mm conduit entry
- 2W LED
- Lithium iron phosphate (LiFePO4) battery technology
- Integrated 3 Hour maintained emergency
- Self Test option available



Order No.	Model No.	Description	Wattage (w)
NEBRASKA LIFE			
2501628817	NNE/M3	2W LED IP65 Maintained 3Hr Lithium Euro	3.5
2501628819	NNE/STM3	2W LED IP65 Maintained 3Hr Self Test Lithium Euro	3.5
2501628821	NNE/DAM3	2W LED IP65 Maintained 3Hr DALI Addressable Lithium Euro	3.5
2501628822	NNE/DAM3/ISO	2W LED IP65 Maintained 3Hr DALI Addressable Lithium ISO	3.5

Order No.	Model No.	Description
LEGENDS		
2501628818	NNE/M3/ISO	2W LED IP65 Maintained 3Hr Lithium ISO Legend Pack
2501628820	NNE/STM3/ISO	2W LED IP65 Maintained 3Hr Self Test Lithium ISO Legend Pack

LED Emergency Wall Exit Box



No re-lamping or maintenance required for lifetime of the fitting

5
YEAR
WARRANTY
50,000 Hours

IP20

Can be installed in maintained switchable, maintained non-switchable and non-maintained mode

Supplied with euro down legend fitted

Maximum viewing distance of 30m

Supplied with Euro legend as standard. ISO legends available separately, please refer to pages 56-57 for differences between legend types

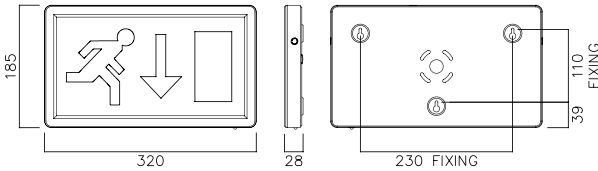

Order No.	Model No.	Description	Wattage (w)
LED EMERGENCY WALL EXIT BOX			
2503005398	NLE3WALLES-LI	2W LED M/NM E3 Wall Exit Box c/w Euro Legend	2

Order No.	Model No.	Description
LEGENDS		
2501421833	NLE3WALLILU	ISO 7010 Legend Arrow Up
2501421834	NLE3WALLILD	ISO 7010 Legend Arrow Down
2501421835	NLE3WALLILL	ISO 7010 Legend Arrow Left
2501421836	NLE3WALLILR	ISO 7010 Legend Arrow Right
2501421829	NLE3WALLESELU	Euro Legend Arrow Up
2501421831	NLE3WALLESELL	Euro Legend Arrow Left
2501421832	NLE3WALLESELR	Euro Legend Arrow Right

LED Emergency Slim Wall Exit Box



Ecolink Emergency Exit sign wall slim is part of the Ecolink Emergency standalone range offering reliable and robust emergency solutions for your projects. It offers a robust solution with UV stabilized polycarbonate construction. This product also comes with an integrated adjustable spot.



- Dual test as standard
- Comes complete with ISO Up legend
- Integral downlight
- Additional legends available
- LiFePO4 battery technology

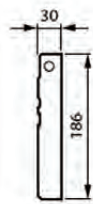
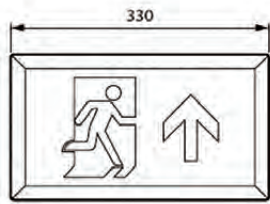

Order No.	Model No.	Description	Wattage (W)	Lumens (lm)	Colour Temp. (K)
LED EMERGENCY SLIM WALL EXIT BOX					
2503040074	912401483649	Slim Exit Box with ISO Up Legend	4	130	6500

Order No.	Model No.	Description
LEGENDS		
2501671602	912401483541	ISO Legend Down Arrow
2501671603	912401483542	ISO Legend Left Arrow
2501671604	912401483543	ISO Legend Right Arrow

Lexington LiFe – Lithium Battery



LED maintained/non-maintained exit box, supplied with Euro arrow down legend, Integrated 3 Hour maintained emergency.



 Exit Box Steel Body
Polycarbonate Legend Panel

 3W LED

 Lithium Iron Phosphate Battery (LiFePO₄)

 Integrated 3 Hour Maintained Emergency

 Self Test option available



Order No.	Model No.	Description
LEXINGTON LiFE – LITHIUM BATTERY		
2501353852	NLE/M3	LED Exit Box Maintained 3Hr
2501164508	NLE/STM3	LED Exit Box Maintained 3Hr Self Test
2501396100	NLE/M3/ISO-U	LED Exit Box Maintained 3Hr ISO Up Legend
2501396101	NLE/STM3/ISO-U	LED Exit Box Maintained 3Hr Self Test ISO Up Legend
2501628836	NLE/DAM3	LED Exit Box Maintained 3Hr DALI Addressable
2501628837	NLE/DAM3/ISO-U	LED Exit Box Maintained 3Hr DALI Addressable ISO Up Legend

Order No.	Model No.	Description
LEXINGTON LiFE – LEGENDS		
2500562536	NLE/LE/UP	Euro Legend Up
2501310691	NLE/LE/DOWN	Euro Legend Down
2500562537	NLE/LE/LEFT	Euro Legend Left
2500562538	NLE/LE/RIGHT	Euro Legend Right
2501628812	NLE/ISO/LE/UP	ISO Legend Up
2501628809	NLE/ISO/LE/DOWN	ISO Legend Down
2501628810	NLE/ISO/LE/LEFT	ISO Legend Left
2501628811	NLE/ISO/LE/RIGHT	ISO Legend Right

LED Emergency Suspended Exit Sign

A suspended LED exit sign with a drop blade and range of legends allowing complete flexibility in any installation.

5
YEAR
WARRANTY
50,000 Hours

IP20

CLASS
1

 No re-lamping or maintenance required for lifetime of the fitting

 Maintained operation with charge indicator lamp

 Maximum viewing distance of 30m

 Supplied with Euro legend as standard. ISO legends available separately, please refer to pages 56-57 for differences between legend types

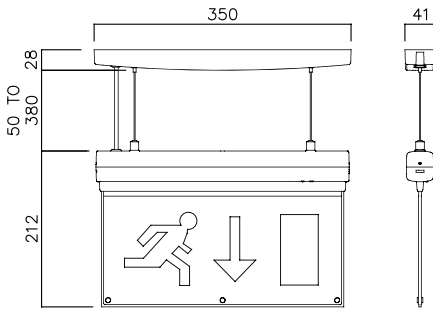

Order No.	Model No.	Description	Wattage (w)
LED EMERGENCY SUSPENDED EXIT SIGN			
2503005396	NLE3SUSES-LI	White Suspended Exit Sign Comes With Euro Legend Arrow Down	3

Order No.	Model No.	Description
LEGENDS		
2501497265	NLE3SUSESELU	Euro Legend Arrow Up
2501497266	NLE3SUSESELLR	Euro Legend Arrow Left/Right
2501497267	NLE3SUSESILU	ISO 7010 Legend Arrow Up
2501497268	NLE3SUSESILLR	ISO 7010 Legend Arrow Left/Right
2501497269	NLE3SUSESILD	ISO 7010 Legend Arrow Down

LED Emergency Exit Blade



Ecolink Emergency Exit sign blade is part of the Ecolink Emergency standalone range offering reliable and robust emergency solutions for your projects. It offers a robust solution with UV stabilized polycarbonate construction. The range offer multiple mounting options for both walls and ceilings.



- Dual test as standard
- Comes complete with ISO up legend
- Wall / ceiling mount options available
- Additional legends available

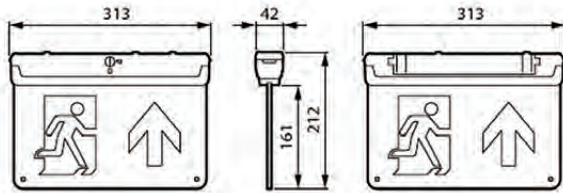

Order No.	Model No.	Description	Wattage (W)	Lumens (lm)	Colour Temp. (K)
LED EMERGENCY EXIT BLADE					
2503040075	912401483650	3W LED Exit Blade with ISO Up Legend	3	24	6500

Order No.	Model No.	Description
LEGENDS		
2501667496	912401483537	ISO Legend Down Arrow
2501667497	912401483538	ISO Legend Left/Right Arrow

Arlington LiFe



Versatile LED exit sign with drop blade for multitude of fixing options, for 3-hour maintained or non-maintained operation.

7 YEAR WARRANTY
50,000 Hours

IP20

CLASS 1

DESIGNER SELECTION



- Material construction
 - White polycarbonate body
 - 5mm thick clear acrylic blade
- Changeable 0.25mm thick acrylic screen printed exit legends
- Suitable for direct fix on ceiling, wall or via vertical conduit mounting
- Optional legends & mounting accessories (Recessed, Wire Suspension & Side Wall)
- Lithium iron phosphate (LiFePO4) battery technology
- Self test option available



Head Positioned so it can be Mounted to the Ceiling



Head Rotated 90° so it can be Mounted to a Wall

7 SEVEN YEAR WARRANTY
Includes Batteries

Order No.	Model No.	Description	Wattage (w)
ARLINGTON LIFE			
2501393711	NAL/M3	LED Maintained 3hr Blade Exit Sign	2
2501309062	NAL/STM3	LED Maintained 3hr Blade Exit Sign Self Test	2
2501628806	NAL/DAM3	LED Maintained 3Hr Blade Exit Sign DALI Addressable	-
2501628807	NAL/DAM3/ISO-U	LED Maintained 3Hr Blade Exit Sign DALI Addressable	-

Order No.	Model No.	Description
ACCESSORIES		
2501219167	NAL/RMK	Recessed Mounting Kit
2501312177	NAL/SWMK	Side Wall Mounting Kit
2501312178	NAL/WSK	Wire Suspension Kit
2501219165	NAL/LE/UP	Euro Legend Running Man Up Pack
2501219163	NAL/LE/LR	Euro Legend Running Man Left/Right Pack
2501628803	NAL/ISO/LE/UP	ISO Legend Up
2501628804	NAL/ISO/LE/LR	ISO Legend Left/Right
2501628805	NAL/ISO/LE/DOWN	ISO Legend Down

Emergency Pin Spot LED Downlight



5
YEAR
WARRANTY

IP40

CLASS
1

The new and upgraded Newlec emergency downlight now features lithium iron phosphate (LiFePO4) battery technology which boasts extended battery life and more efficient charging. It is a stand-alone recessed mounted emergency LED which avoids the need for unsightly surface bulkheads, or conversion of existing luminaires.

- Small & discreet non-maintained emergency down-light
- Wide symmetrical 145 degree distribution
- LiFePO4 battery technology
- 60mm cut out

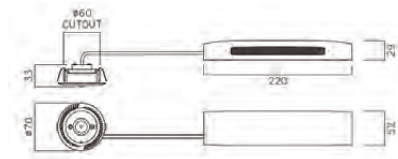
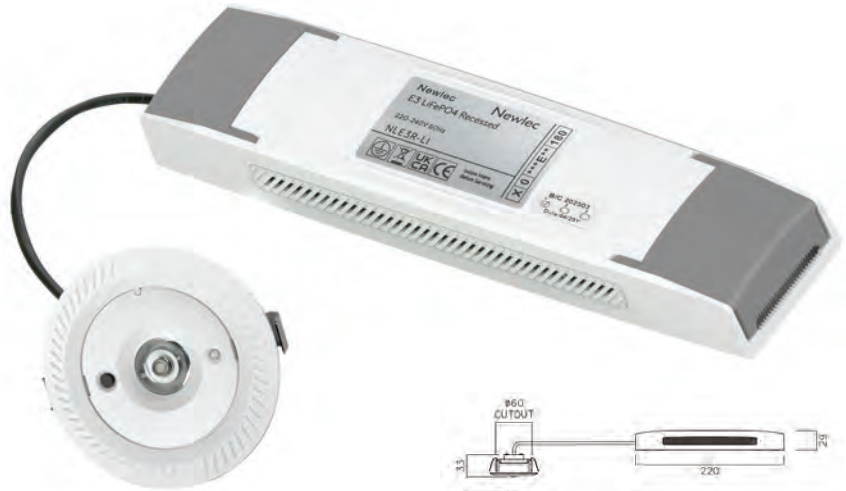

Order No.	Model No.	Description	Wattage (W)	Lumens (lm)	Colour Temp. (K)
EMERGENCY PIN SPOT LED DOWNLIGHT					
2503005395	NLE3R-LI	Emergency Pin Spot LED Downlight	1	115	6500K

Emergency Downlight



5
YEAR
WARRANTY

IP20

Ecolink Emergency Recessed spot is part of the Ecolink Emergency standalone range offering reliable and robust emergency solutions for your projects. It offers a reliable and versatile solution with interchangeable lenses: Corridor and Open area.

- Dual test as standard
- Multiple optics included for corridor and open area
- LiFePO4 battery technology

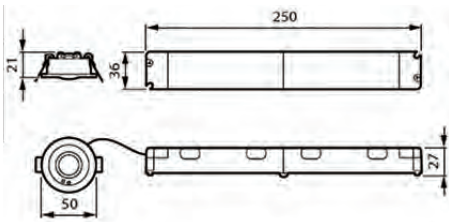

Order No.	Model No.	Description	Wattage (W)	Lumens (lm)	Colour Temp. (K)
EMERGENCY DOWNLIGHT					
2503040072	912401483647	Recessed Emergency Downlight	1	120	6500K
2503040073	912401483648	Surface Mount Emergency Spotlight	2	250	6500K

Emergency Conversion Kit



5
YEAR
WARRANTY

2
YEAR
WARRANTY
On-Site

IP65

The Neka and Niah offer an additional add-on, non-maintained emergency lighting solution when used with LED luminaires. Featuring a long battery life of 7 years, they are a cost effective, easy to install addition to all existing luminaires where emergency lighting is required.

- Switchable manual & self-test
- Non-maintained operation
- Self-Adhesive, IP65 rated LED pad
- No drilling required
- Fast and easy installation



Order No.	Model No.	Description	Wattage (W)	Lumens (lm)	Colour Temp. (K)
EMERGENCY CONVERSION KITS					
2503042035	EMPAD01/SST	Self Adhesive Emergency LED Pad	1	100	6000K
2503042036	EMPAD02/SST	Self Adhesive Emergency LED Pad	3.5	200	6000K

Seneca Recessed Life



A recessed mounted emergency LED which avoids the need for unsightly surface bulkheads.

7*
YEAR WARRANTY
50,000 Hours
*Includes batteries

IP40

CLASS 1

- Lithium Ion Phosphate (LiFePO4) battery
- Non-Maintained operation with a momentary test button fitted
- Changeable lens that offers both wide and oval light distribution
- Up to 50% saving versus Nickel cadmium (NiCd) batteries
- Self Test option available
- 60mm cut out



7
SEVEN YEAR WARRANTY
Includes Batteries

Order No.	Model No.	Description
SENECA RECESSED LIFE		
2501312166	NSC3/REC/NM3	LED Emergency Recessed Downlight Manual Test
2501312167	NSC3/REC/STNM3	LED Emergency Recessed Downlight Self Test
2503010962	NSC/BK/REC/NM3	LED Emergency Recessed Downlight Black

Seneca Surface Life



IP40 dedicated LED surface emergency fittings, changeable acrylic lens - wide or oval, Lithium Iron Phosphate (LiFePO4) Battery.

7*
YEAR WARRANTY
*Includes batteries

IP20

CLASS 1

- Polycarbonate construction
- Acrylic Lens - Oval or Wide Lens distribution
- Lithium iron phosphate (LiFePO4) battery technology
- 2W
- 3 Hour non-maintained emergency
- Self test option available



7
SEVEN YEAR WARRANTY
Includes Batteries



Order No.	Model No.	Description
SENECA SURFACE LIFE		
2501353854	NSC/SURF/NM3	LED Emergency Surface Mount Downlight Manual Test
2501353855	NSC/SURF/STNM3	LED Emergency Surface Mount Downlight Self Test
2503010961	NSC/BK/IP65/SURF/RD/NM3	LED Emergency Surface Mount Downlight Black

LED IP65 Emergency Twinspot



A range of emergency twinspots with twin heads that can rotate and tilt. The fitting can also be mounted in any orientation for flexibility during installation. Suitable for general emergency lighting applications in commercial and industrial use.



-  Polycarbonate body
Polycarbonate heads, including lens
-  Push fit terminal block for quick and simple installation
-  3 hour non-maintained

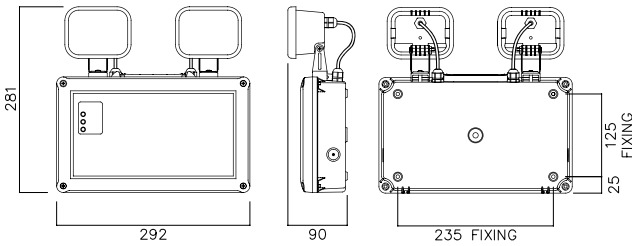

Order No.	Model No.	Description
LED IP65 EMERGENCY TWINSPOT		
2503005397	NLE3TWINSP-LI	2 X 1.5W LED Non-Maintained Twinspot



250+

Branches nationwide

Scan the QR code to find your local branch



Emergency Twinspot



Ecolink twin spot is part of the Ecolink Emergency standalone range offering reliable and robust emergency solutions for your projects. The twin spot luminaire offers 1000lums of high-quality light, ideal for industrial applications with IP65 protection. The product comes with twin tiltable heads and 3 hours of emergency back up with its reliable Lithium Ferro Phosphate battery.



- Dual test as standard
- LiFePO4 Battery technology
- 3 hour non-maintained operation

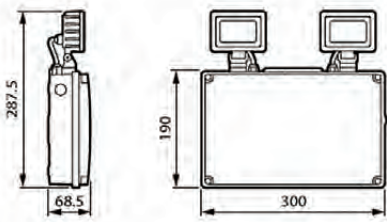

Order No.	Model No.	Description	Wattage (W)	Lumens (lm)	Colour Temp. (K)
EMERGENCY TWINSLOT					
2503040071	912401483646	LED Emergency Twinspot	9	2x500	6500

Kansas Life



A range of emergency twinspots with twin heads that can rotate and tilt. The fitting can also be mounted in any orientation for flexibility during installation. Suitable for general emergency lighting applications in commercial and industrial use.



- Polycarbonate body
Polycarbonate heads, including lens
- Push fit terminal block for quick and simple installation
- 3 hour non-maintained



Order No.	Model No.	Description	Wattage (w)
KANSAS LIFE			
2501628808	NKS/NM3	Twinspot IP20 LED	6
2501541262	NKS/IP65/NM3	Twinspot IP65 LED	2x3
2501378275	NKS/IP65/STNM3	Twinspot IP65 LED Self Test	2x3
2501628827	NKS/IP65/DA/NM3	Twinspot IP65 LED DALI	-
2503010963	NKS/BK/IP65/NM3	Twinspot IP65 LED Black Body	-

07 | Industrial & Hazardous Area



Scan here to see our
full range online



LED Non-Corrosive

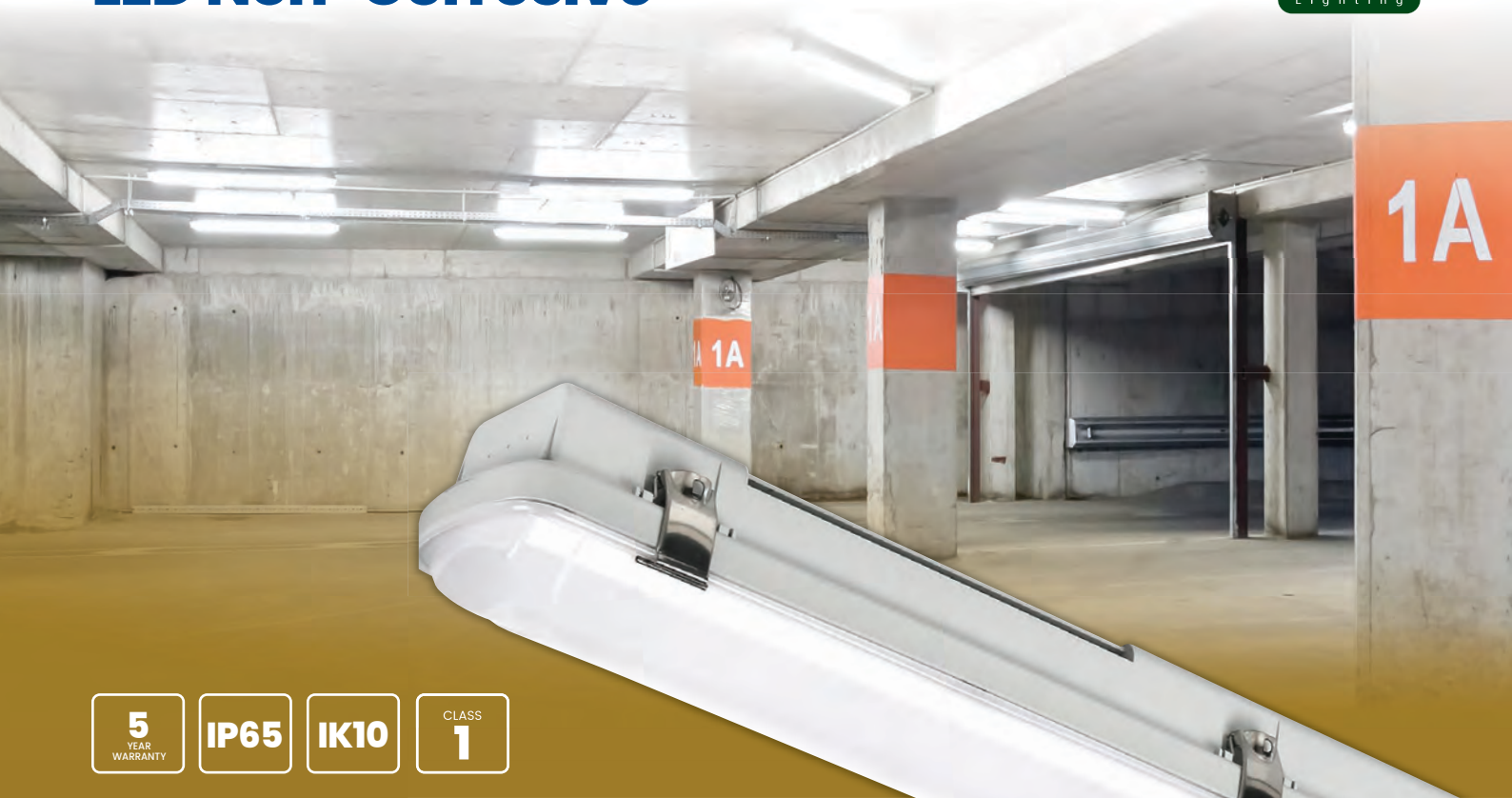

5
YEAR
WARRANTY

IP65

IK10

CLASS
1

The Columbus light fitting offers exception efficiency at up to 154lm/w, delivering up to 9566 lumens with a robust and practical design. Its sleek, durable construction makes it an ideal choice for illuminating large indoor spaces and outdoor under-canopy areas.

- Material Construction:
 - Grey polycarbonate body
 - UV stable opal polycarbonate
 - Stainless steel clips
- Wattage switchable for maximum flexibility
- Tool-free terminal block
- Suitable for surface mount, or chain/wire suspension
- Pre-moulded drill points for BESA fixing
- ENEC approved flicker-free driver
- Plug & Play Microwave Sensor available on request







Order No.	Model No.	Description	Wattage (W)	Lumens (lm)	Colour Temp. (k)
LED NON-CORROSIVE					
2503016109	NCB/4/15-26/840	4ft Single	15/19/22/26	2090-3567	4000K
2503016120	NCB/4/22-40/840	4ft Twin	22/28/34/40	3429-5557	4000K
2503016131	NCB/5/20-36/840	5ft Single	20/25/30/36	2739-4027	4000K
2503016142	NCB/5/30-52/840	5ft Twin	30/38/45/52	4397-6936	4000K
2503016151	NCB/6/27-47/840	6ft Single	25/31/38/44/51/57/64/71	3806-9566	4000K
2503016150	NCB/6/25-71/840	6ft Twin	27/33/40/47	3695-5748	4000K
2503035724	NCB/4/15-26/M3L/840	4ft Single Emergency	15/19/22/26	2090-3567	4000K
2503035725	NCB/4/22-40/M3L/840	4ft Twin Emergency	22/28/34/40	3429-5557	4000K
2503035726	NCB/5/20-36/M3L/840	5ft Single Emergency	20/25/30/36	2739-4027	4000K
2503035727	NCB/5/30-52/M3L/840	5ft Twin Emergency	30/38/45/52	4397-6936	4000K
2503035729	NCB/6/27-47/M3L/840	6ft Single Emergency	27/33/40/47	3695-5748	4000K
2503035728	NCB/6/25-71/M3L/840	6ft Twin Emergency	25/31/38/44/51/57/64/71	3806-9566	4000K
2503016148	N/LINEAR/M3L/CONV-PACK	Emergency Conversion Pack			

LED Non-Corrosive



- 5
YEAR
WARRANTY
- IP65
- IK08

Ecolink Non-Corrosives are part of the Ecolink range offering high quality, reliable and lighting solutions for your projects. The Ecolink Non-Corrosive fittings are available in 4, 5 and 6ft lengths and offers up to 8400lum of high-quality. Ease of installation is offered with easy to open Stainless steel clips, ceiling and suspended mounting clips supplied by default.

-  Material Construction:
Body and diffuser: Polycarbonate
-  Stainless steel clips
-  High quality Philips driver
-  Self Test Emergency Kit
-  CRI > 80

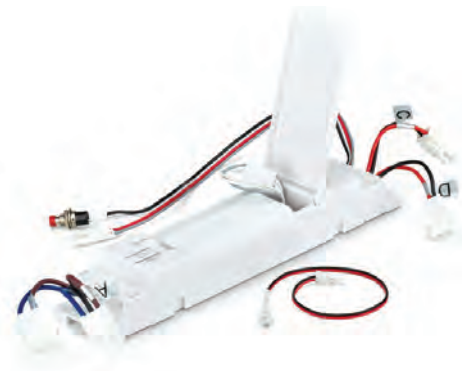





Order No.	Model No.	Description	Wattage (W)	Lumens (lm)	Efficacy (lm/W)	Colour Temp. (K)
LED NON-CORROSIVE						
2501662949	911401821087	4ft Single	22	2400	109	4000K
2501662950	911401820987	4ft Twin	44	4800	109	4000K
2501662951	911401820887	5ft Single	31	3500	113	4000K
2501662952	911401820787	5ft Twin	53	6800	128	4000K
2501662953	911401821287	6ft Single	44	4400	100	4000K
2501662954	911401821187	6ft Twin	65	8400	129	4000K
2503039103	912401483603	Emergency Pack Manual & Self Test				

CCT & Power Switchable Non-Corrosive



Must be registered

Aurora's brand new LinearPacCWS Anti Corrosive offers a market leading 180 lumens per watt giving high quality, high efficiency light. The fitting features plug and play style emergency, sensor and DALI conversion kits.

-  Material Construction:
 - Polycarbonate base and opal polycarbonate diffuser
-  Plug-and-play emergency packs, microwave sensors and DALI conversion kits
-  Wattage and colour selectable
-  High efficiency of up to 180lm/w
-  Stainless steel clips

Order No.	Model No.	Description	Wattage (W)	Lumens (lm)	Colour Temp. (K)
CCT & POWER SWITCHABLE NON-CORROSIVE					
2503005082	AU-ANT600CWS	2ft 600mm	7-14	1155-2380	3000/4000/6500K
2503005084	AU-ANT1200CWS	4ft 1200mm	14-28	2310-4760	3000/4000/6500K
2503005085	AU-ANT1500CWS	5ft 1500mm	18-36	2970-6120	3000/4000/6500K
2503005086	AU-ANT1800CWS	6ft 1800mm	27-54	4455-9180	3000/4000/6500K

Order No.	Model No.	Description
ACCESSORIES		
2503005087	AU-ANTEM2	Emergency Pack
2503005088	AU-ANTEMST2	Self Test Emergency Pack
2503005089	AU-ANTMSC2	Microwave Sensor with Corridor Function
2503005090	AU-ANTDA1	DALI Conversion Pack for 2ft
2503005091	AU-ANTDA2	DALI Conversion Pack for 4ft & 5ft
2503005083	AU-ANTDA3	DALI Conversion Pack for 6ft





Clipless Non-Corrosive

ROBUS®

NEW
Available from
September
2026



HARBOUR EXPRESS EDGE features a new hinged design—no clips! There's an added in-line connector so you can completely detach the base and diffuser without compromising any internal wiring. Install the base first and come back when it suits you. From first fix to final fit, this is an apprentice friendly, contractor-approved design.

-  Material Construction:
-Polycarbonate base and diffuser
-  Up to 175Lm/W efficacy
-  Hinged design with no clips
-  Power and CCT switchable
-  BESA mountable

Order No.	Model No.	Description	Wattage (W)	Colour Temp. (K)
CLIPLESS NON-CORROSIVE				
2503047026	RHEE16X2FT-24	2ft 600mm	8/10/13/16	4000/5000/6500K
2503047029	RHEE32X4FT-24	4ft 1200mm	16/20/26/32	4000/5000/6500K
2503047027	RHEE20X5FT-24	5ft 1500mm Low Output	10/13/16/20	4000/5000/6500K
2503047005	RHEE50X5FT-24	5ft 1500mm Medium Output	25/33/40/50	4000/5000/6500K
2503047006	RHEE50X5FTE-24	5ft 1500mm Medium Output Emergency	25/33/40/50	4000/5000/6500K
2503047007	RHEE70X5FT-24	5ft 1500mm High Output	35/46/56/70	4000/5000/6500K
2503047028	RHEE30X6FT-24	6ft 1800mm	15/18/24/30	4000/5000/6500K

Greenland PRO Non-Corrosive



7
YEAR WARRANTY
100,000 Hours

IK10

IP66

Introducing NVC's new Greenland Pro non-corrosive, with a host of features to enable quicker and easier installs, such as moveable terminal blocks, pre-drilled cable/conduit entry points and elongated mounting clip grooves. Suitable for industrial environments with high efficiency and long life.

- Material Construction:**
 - Polycarbonate base and opal polycarbonate diffuser
- Microwave sense, DALI, Corridor Function, Casambi and HubSense variants available
- 2-part construction - Base and Light Engine, enabling quicker and easier first and second fix
- 4-way wattage switchable, removing need for single and twin variants
- Wattage and colour selectable
- Up to 169 lumens per watt efficiency
- Stainless steel clips

Order No.	Model No.	Description	Wattage (W)	Lumens (lm)	Efficacy (lm/W)	Colour Temp. (K)
GREENLAND PRO						
2503039877	NGN2/6-12/827-40-60	2ft 600mm	6-12	780-1560	130	2700/4000/6000K
2503039879	NGN4/20-38/827-40-60	4ft 1200mm Standard	20-38	3160-5890	159	2700/4000/6000K
2503039898	NGN4/20-38/M3L/827-40-60	4ft 1200mm Emergency	20-38	3160-5890	159	2700/4000/6000K
2503039929	NGN5/27-48/827-40-60	5ft 1500mm Standard	27-48	4239-7392	157	2700/4000/6000K
2503039939	NGN5/27-48/M3L/827-40-60	5ft 1500mm Emergency	27-48	4239-7392	157	2700/4000/6000K
2503039972	NGN6/34-60/827-40-60	6ft 1800mm Standard	34-60	5270-9000	155	2700/4000/6000K
2503039880	NGN6/34-60/M3L/827-40-60	6ft 1800mm Emergency	34-60	5270-9000	155	2700/4000/6000K

Inspection Pit Light



- 5
YEAR
WARRANTY
- IK10
- IP69

The Pit Eco is an IP69K-sealed luminaire for rail and heavy industry environments. The end caps are fabricated from 316 stainless steel. The housing is polycarbonate or acrylic depending on agent exposure, with an IK10 rating and features flexible mounting/wiring options.

- Material Construction:
 - Polycarb or PMMA diffuser
 - 316L stainless steel end caps and brackets
- Opal or clear diffuser options
- Variety of colour temperatures available on request
- Through Wiring, Emergency, DALI options available on request

Order No.	Model No.	Description	Wattage (W)	Lumens (lm)	Efficacy (lm/W)	Colour Temp. (K)
INSPECTION PIT LIGHT						
2503049296	PEC-60-15-4K-FRPC	5ft Frosted Polycarbonate	60	7200	120	4000K
2503049297	PEC-60-15-4K-FRPM	5ft Frosted PMMA	60	7200	120	4000K
2503049298	PEC-60-15-4K-CLPM	5ft Clear PMMA	60	8400	140	4000K

LED Highbay



5
YEAR
WARRANTY

3
YEAR
WARRANTY
On Site

IK10

IP65

Must be registered



The 185lm/W Cosmos highbay range is a highly efficient lighting solution that delivers the same lumens as traditional 100/150/200W highbays for up to 25% less power.

- High efficiency up to 185lm/W
- 1-10V dimmable as standard
- 110° beam angle
(60° and 90° lenses available on request)
- 40° - +50° working temperature



Order No.	Model No.	Description	Wattage (W)	Lumens (lm)	Emergency	Colour Temp. (K)
LED HIGHBAY						
2503024292	HBD80/40	80W LED Highbay	80	14,800	No	4000K
2503024293	HBD80EM/40	80W LED Highbay Emergency	80	14,800	Yes	4000K
2503024294	HBD120/40	120W LED Highbay	120	22,200	No	4000K
2503024295	HBD120EM/40	120W LED Highbay Emergency	120	22,200	Yes	4000K
2503024296	HBD150/40	150W LED Highbay	150	27,750	No	4000K
2503024297	HBD150EM/40	150W LED Highbay Emergency	150	27,750	Yes	4000K

Order No.	Model No.	Description
ACCESSORIES		
2503024304	HBDPIR	PIR Sensor
2503024305	HBDMSC	Microwave Sensor with Corridor Function
2503024306	HBDRC	Remote Controller
2503024301	HBDRFA	Aluminium Reflector for 80W
2503024302	HBDRFB	Aluminium Reflector for 120W and 150W
2503024303	HBDMB	Surface Mount Bracket

LED Highbay





5
YEAR
WARRANTY

IP65

The Ecolink Highbay is part of the Ecolink range offering high quality, reliable and lighting solutions for your projects. The Ecolink highbay is available in 3 different wattages covering a wide range of applications. Energy efficiency is a key feature of this product with 150lm/W system efficacy. Installation is made easy with eyebolt included in the packaging.



 Material construction:
Body: Die-cast aluminium
Lens: Polycarbonate

 High 150lm/w efficacy

 Operating temperature -20°C - 45°C

Order No.	Model No.	Description	Wattage (W)	Lumens (lm)	Efficacy (lm/W)	Colour Temp. (K)
LED Highbay						
2503006899	911401565344	70W LED Highbay	70	10,500	150	4000K
2503006900	911401565444	133W LED Highbay	133	20,000	150	4000K
2503006901	911401565544	185W LED Highbay	185	28,000	150	4000K

All in One LED Highbay



- 5
YEAR
WARRANTY
- IP65
- IK08

The Luceco Titan All in One Highbay Light, combined with 3 accessory SKUs, replaces up to 72 different SKUs – offering contractors unmatched convenience and flexibility for on-site adjustments. Engineered to withstand the toughest environments, IP65 & IK08 rated, and backed by a 5-year warranty for peace of mind, making Luceco's Titan All-in One a perfect lighting solution for commercial or industrial environments such as warehouses, factories and sports halls.



- Die-cast aluminium housing
- Up to 170lm/w efficiency
- Power & CCT switchable
- Adjustable beam angle
- 100,000 hour life



Order No.	Model No.	Description	Wattage (W)	Lumens (lm)	Efficacy (lm/W)	Colour Temp. (K)
ALL-IN-ONE LED Highbay						
2503004936	LHBB31DCC-01	All in One 1-10V Dimmable Power & Wattage Switchable LED Highbay	100/150/200	17,500/25,000/31,000	170	4000/5000/6500K

Order No.	Model No.	Description
ACCESSORIES		
2503004931	LHBEM3ET8W-01	Emergency Pack
2503027208	LHBZHP-02	PIR Sensor
2503004932	LHBREM-01	Remote Control

LED Lowbay



5
YEAR
WARRANTY
50,000 Hours

3
YEAR
WARRANTY
On Site
Must be registered

IK08

IP65

Introducing the LowBayCWS, the ideal lighting solution tailored for industrial environments, capable of delivering up to 30,000 lumens of robust, high-quality illumination. Whether you're lighting up a warehouse, manufacturing plant, or any other large industrial space, the LowBayCWS ensures that every corner is well-lit, enhancing both visibility and safety. It's more than just a lighting fixture—it's a versatile, energy efficient solution that adapts to your industrial environment, ensuring optimal performance and cost-effectiveness.



- Wattage and colour switchable for maximum versatility
- 1-10V dimmable as standard
- 90° beam angle
- Asymmetric beam variant available on request



Order No.	Model No.	Description	Wattage (W)	Lumens (lm)	Emergency	Colour Temp. (K)
LED LOWBAY						
2503024307	LB10ICWS	Standard	120/160/200	18000-30000	No	4000/5000K
2503024308	LB10ICWSEM	Emergency	120/160/200	18000-30000	Yes	4000/5000K

Order No.	Model No.	Description
ACCESSORIES		
2503024310	HBDPIRW	PIR Sensor
2503024309	HBDMSCW	Microwave Sensor with Corridor Function
2503024306	HBDRC	Remote Controller
2503024311	LBSMK	Surface Mount Kit

Order by 5pm for next day delivery

LED Commercial/Industrial Floodlights

PHILIPS





Outdoor LED floodlights suitable for a wide range of applications such as commercial or industrial areas, car parks, etc.

 Material Construction:
Die cast aluminium housing
Polycarbonate diffuser

 Grey finish

 Pre-wired with 2m cable

 Adjustable mounting bracket

 Beam angle 110° x 110°

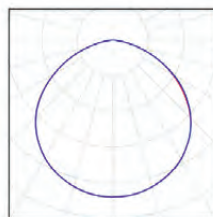

Order No.	Model No.	Description	Wattage (w)	Lumens (lm)	Colour Temp. (K)
LED COMMERCIAL/INDUSTRIAL FLOODLIGHTS					
2503000094	911401875386	70W Floodlight	70	8400	3000/4000/6500K
2503000095	911401876386	100W Floodlight	100	12000	3000/4000/6500K
2503000096	911401877386	150W Floodlight	150	18000	3000/4000/6500K
2503000097	911401878386	200W Floodlight	200	24000	3000/4000/6500K
2503000102	911401875586	65W Floodlight with Photocell	65	7350	3000/4000/6500K
2503000103	911401876586	100W Floodlight with Photocell	90	10500	3000/4000/6500K
2503000104	911401877586	135W Floodlight with Photocell	135	15750	3000/4000/6500K
2503000105	911401878586	180W Floodlight with Photocell	180	21000	3000/4000/6500K

LED Commercial/Industrial Floodlight – Asymmetric



5
YEAR
WARRANTY
50,000 Hours

IP65

IK08

**CRI
80+**

Outdoor LED floodlights suitable for a wide range of applications such as commercial or industrial areas, car parks, etc.

Material Construction:
Die cast aluminium housing
Polycarbonate diffuser

Grey finish

Pre-wired with 2m cable

Adjustable mounting bracket

Beam angle 40° x 83°

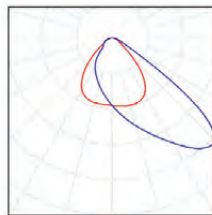

Order No.	Model No.	Description	Wattage (W)	Lumens (lm)	Colour Temp. (K)
LED COMMERCIAL/INDUSTRIAL FLOODLIGHT - ASYMMETRIC					
2503000098	911401883386	65W Floodlight	65	7350	3000/4000/6500K
2503000099	911401884386	90W Floodlight	90	10,500	3000/4000/6500K
2503000100	911401885386	135W Floodlight	135	15,750	3000/4000/6500K
2503000101	911401886386	180W Floodlight	180	21,000	3000/4000/6500K
2501620435	911401883586	70W Floodlight with Photocell	65	7300	3000/4000/6500K
2501620436	911401884586	100W Floodlight with Photocell	90	10,500	3000/4000/6500K
2501620437	911401885586	150W Floodlight with Photocell	135	15,700	3000/4000/6500K
2501620438	911401886586	200W Floodlight with Photocell	180	21,000	3000/4000/6500K

High Power LED Floodlight



3
YEAR
WARRANTY

IP65

IK08

CRI
80+

With output of up to 60,000 lm, this floodlight packs a serious punch. Its high-quality LED technology ensures exceptional energy efficiency, with system efficacy of 120 lm/W. The Ledinaire floodlight high wattage also boasts impressive durability, with a protection class of Class I and an IP65 rating. Its robust construction and IK08 rating make it suitable for even the toughest outdoor environments.

-  Material Construction:
Die cast aluminium housing
Glass lens
-  Grey finish
-  Pre-wired with 1m cable
-  Adjustable mounting bracket
-  Symmetrical 110° beam angle



Order No.	Model No.	Description	Wattage (W)	Lumens (lm)	Efficacy (lm/W)	Colour Temp. (K)
HIGH POWER LED FLOODLIGHT						
2503031395	911401843987	250W Floodlight	250	30,000	120	4000K
2503031396	911401844087	300W Floodlight	300	36,000	120	4000K
2503031397	911401844187	400W Floodlight	400	48,000	120	4000K
2503031398	911401844287	500W Floodlight	500	60,000	120	4000K

REXEL

Ledinaire Floodlight Solar gen2

All you need to pack for your next job



PHILIPS

Think outside the grid with flexible, energy-efficient, and cost-effective Philips Ledinaire Floodlight Solar gen2. Easy to install with no wiring required, this robust, weatherproof floodlight is 100% powered by the sun.

- Energy-efficient and environmentally friendly
- Easy to install with no wiring or electrical work needed
- Convenient dusk-to-dawn automation and integrated PIR motion sensor
- 2 lumen packages (2200–2400 lm / 4600–4800 lm)
- Use the remote control to switch between 3 CCTs (3000 K / 4000 K / 6500 K)
- LED indicator for battery capacity level
- IP66-rated for reliable operation in damp and wet conditions outdoors
- Long lifetime of 75,000 hrs



Philips Ledinaire Floodlight Solar gen2 3-in-1 product codes.

Product description	12NC
VVP085 LEDINAIRE SOLAR FLOODLIGHT 2400LM 3CCT	911401838203
VVP085 LEDINAIRE SOLAR FLOODLIGHT 4800LM 3CCT	911401838303



Learn more about Philips Ledinaire luminaires—trusted performance, every day.



Zone 1 Linear LED



Low maintenance, High output LED light source and energy efficient control with motion sensor options for controlling single and multiple fittings. Manufactured from impact resistant polycarbonate and high specification marine grade aluminium, the fitting is supplied anodised and painted.

- Material Construction:
Body - Marine Grade Aluminium
Diffuser - High Impact Polycarbonate
- Rated for Zones 1, 2 and 21 & 22
- Suitable for offshore applications
- 240V - Other voltage options available on request

Order No.	Model No.	Description	Wattage (w)	Lumens (lm)	Length (mm)	Emergency
ZONE 1 LINEAR LED						
2501603076	7LED1700/R2	1ft Zone 1 Linear	15	1,335	448	No
2450020987	7LED1700/EM/R2	1ft Zone 1 Linear	15	1,335	448	Yes
2501603077	7LED2700/R2	2ft Zone 1 Linear	30	2,670	752	No
2503000614	7LED2700/EM/R2	2ft Zone 1 Linear	30	2,670	752	Yes
2450020988	7LED4700/R2	4ft Zone 1 Linear	55	5,340	1362	No
2450020989	7LED4700/EM/R2	4ft Zone 1 Linear	55	5,340	1362	Yes
2450068731	7LED5700/R2	5ft Zone 1 Linear	70	6,675	1662	No
2450020990	7LED5700/EM/R2	5ft Zone 1 Linear	70	6,675	1662	Yes

Zone 1 Linear LED

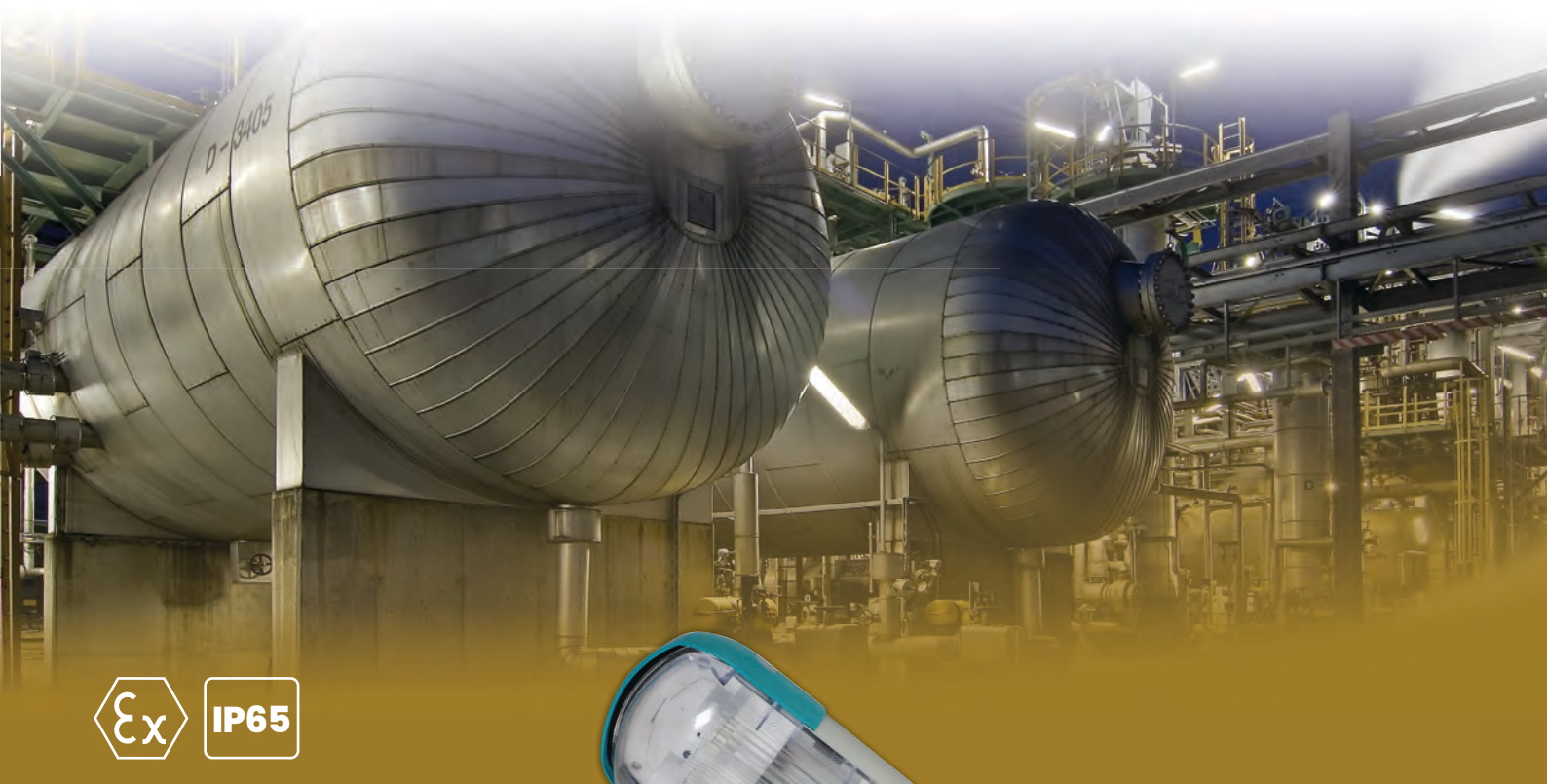

Manufactured from heavy duty aluminium extrusion with polycarbonate end caps and diffuser. The three hour duration emergency models are fitted with integral batteries and charger units. Access to the gear tray is via a single point locking mechanism and mounting is enabled using "quick fit" T bolts in a channel for maximum flexibility. The modern styling of this extremely rigid and robust luminaire allows unobtrusive use for both internal and external applications.



 Material Construction:
 Body - Anodised Corrosion Resistant Aluminium
 Diffuser - UV Resistant High Impact Polycarbonate

 Rated for Zones 1, 2 and 22





Order No.	Model No.	Description	Wattage (w)	Lumens (lm)	Length (mm)	Emergency
ZONE 1 LINEAR LED						
2501310718	9LED2700	2ft Zone 1 Linear	30	2,106	760	No
2501310719	9LED2700/EM	2ft Zone 1 Linear	30	2,106	760	Yes
2501171131	9LED4700	4ft Zone 1 Linear	60	4,212	1365	No
2501310721	9LED4700/EM	4ft Zone 1 Linear	60	4,212	1365	Yes
2450019499	9LED5700	5ft Zone 1 Linear	75	5,265	1665	No
2450020984	9LED5700/EM	5ft Zone 1 Linear	75	5,265	1665	Yes

Zone 2 Linear LED



A highly competitive zone 2 LED luminaire for use in both internal and external hazardous area applications. Available in a range of sizes from 2-5ft with light output up to 6,637 Lumens.



-  Material Construction:
Body - Moulded GRP
Diffuser - Polycarbonate
-  Coated steel control gear tray, corrosion resistant gear tray and diffuser, EPDM, closed-cell gasket
-  Rated for Zones 2 and 22
-  Microwave sensor versions available on request

Order No.	Model No.	Description	Wattage (W)	Lumens (lm)	Length (mm)	Emergency
ZONE 2 LINEAR LED						
2501310715	XNLED127	2ft Zone 2 Linear	30	2,655	702	No
2501310716	XNLED147	4ft Zone 2 Linear	60	5,310	1312	No
2501310717	XNLED147/EM	4ft Zone 2 Linear	60	5,310	1312	Yes
2450020992	XNLED157	5ft Zone 2 Linear	75	6,637	1612	No
2450020986	XNLED157/EM	5ft Zone 2 Linear	75	6,637	1612	Yes

Zone 1 Area / Flood Light

Certified for use in Zone 1, 21, 2, 22 this is a modern and versatile range of luminaires. The high quality corrosion resistant aluminium body gives excellent durability in any Zone 1 & 2 hazardous environment. The LED light engine provides a long service life which is virtually maintenance free. All products in the range are offered with a light engine warranty of up to 5 years. The whole range offers industry leading performance in terms of lumen per watt efficacy.



Material Construction:
Body - Corrosion resistant aluminium alloy
Lens - Tempered glass

Chemical and abrasion resistant polycarbonate lens available on request

Rated for Zones 2 and 22

Order No.	Model No.	Description	Wattage (w)	Lumens (lm)
ZONE 1 AREA / FLOOD LIGHT				
2450020976	ALED2/G/Z1/045	Zone 1 Area/Flood Light	45	4,750
2501263164	ALED3/G/Z1/086	Zone 1 Area/Flood Light	86	10,500
2501310713	ALED4/G/Z1/156	Zone 1 Area/Flood Light	156	19,000

Zone 2 Area / Flood Light

Certified for use in Zone 1, 21, 2, 22 this is a modern and versatile range of luminaires. The high quality corrosion resistant aluminium body gives excellent durability in any Zone 1 & 2 hazardous environment. The LED light engine provides a long service life which is virtually maintenance free. All products in the range are offered with a light engine warranty of up to 5 years. The whole range offers industry leading performance in terms of lumen per watt efficacy.



Material Construction:
Body - Corrosion resistant aluminium alloy
Lens - Tempered glass

Chemical and abrasion resistant polycarbonate lens available on request

Rated for Zones 2 and 22

Order No.	Model No.	Description	Wattage (w)	Lumens (lm)
ZONE 2 AREA / FLOOD LIGHT				
2450020977	ALED2/G/Z2/045	Zone 2 Area/Flood Light	45	5,750
2450020979	ALED3/G/Z2/086	Zone 2 Area/Flood Light	86	12,500
2450020981	ALED4/G/Z2/156	Zone 2 Area/Flood Light	156	22,500

AVAILABLE NOW

cinch

Cars without
the faff

Welcome to our gaff

cinch
Cars without the faff

Opening times

Monday	10am - 7pm
Tuesday	10am - 7pm
Wednesday	10am - 7pm
Thursday	10am - 7pm
Friday	10am - 7pm
Saturday	10am - 6pm
Sunday	10am - 6pm

NISEKO

BESPOKE SIGN LIGHT COLLECTION

Introducing the Niseko Bespoke Sign Light Collection – a pinnacle of lighting innovation, guaranteed by a robust 3-year warranty. This collection is not merely a custom-made offering; it represents a commitment to long-lasting quality and superior performance.

- ✓ Variety of outputs, colour options and light sources
- ✓ Flexible sizes ranging from 600-6000mm
- ✓ Power feed options either on the left or right
- ✓ Simple installation, with 250mm or 500mm brackets



KSR
LIGHTING

ENQUIRE IN STORE TODAY

THE ULTIMATE LIGHTING SOLUTION



08 | Sports & High Mast

Scan here to see our
full range online



Sports Floodlight Asymmetric Beam

ROBUS®



The STADION LED sports light delivers 86,000lm to 264,000lm, providing a flexible solution for medium and large stadium lighting. Its modular design features tilt-adjustable single LED modules for precise beam control, which could effectively control glare and ensure the good uniformity. Available as narrow (15x110°), medium (25x120°) or wide (25x130°) asymmetric beam angle versions. With specialized materials and surface treatment, the STADION offers exceptional corrosion resistance, making it an excellent choice for harsh environments.

- Modular tilt-adjustable LED modules for precise beam and glare control
- Equipped with 20kV surge protection
- 100,000 hour life
- DALI as standard, 0-10V and DMX available on request
- Remote mounted driver up to 50m



Order No.	Model No.	Description	Wattage (w)	Lumens (lm)	Colour Temp. (K)
SPORTS FLOODLIGHT ASYMMETRIC BEAM					
2503047018	RSD6057M-04	Medium Beam	600	90,040	5700K
2503047019	RSD6057N-04	Narrow Beam	600	86,780	5700K
2503047020	RSD6057W-04	Wide Beam	600	90,220	5700K
2503047010	RSD12057M-04	Medium Beam	1200	172,990	5700K
2503047011	RSD12057N-04	Narrow Beam	1200	167,100	5700K
2503047012	RSD12057W-04	Wide Beam	1200	176,450	5700K
2503047014	RSD18057M-04	Medium Beam	1800	259,480	5700K
2503047015	RSD18057N-04	Narrow Beam	1800	249,900	5700K
2503047016	RSD18057W-04	Wide Beam	1800	264,670	5700K
2503047021	RSD60-SB	Stirrup Mount for 600W			
2503047013	RSD120-SB	Stirrup Mount for 1200W			
2503047017	RSD180-SB	Stirrup Mount for 1800W			
2503047022	RSD-AS	Aiming Scope			
2503047023	RSD-CB	Clamp Bracket for Driver			
2503047024	RSD-VA	Front Visor			

Sports Lighting Lux Guide

Ud: Uniformity distribution

Also referred to as U0. Evaluates the evenness of light levels in an area, with higher values (on a scale of 0-1) indicating better uniformity. Boundary zones must be considered to ensure accurate analysis.

GR: Glare rating

Evaluates the degree of discomfort glare caused by lighting devices in outdoor areas.

SPORT	CLASS I (Lux / Ud / GR)	CLASS II (Lux / Ud / GR)	CLASS III (Lux / Ud / GR)
ATHLETICS	500 / 0.7 / 50	200 / 0.7 / 50	100 / 0.5 / 55
BASEBALL	500 / 0.5 / 50	300 / 0.5 / 50	200 / 0.3 / 55
BASKETBALL	-	-	75 / 0.5 / 55
BEACH VOLLEYBALL	500 / 0.7 / -	200 / 0.6 / -	75 / 0.5 / -
BOWLS	200 / 0.7 / 50	200 / 0.7 / 50	100 / 0.7 / 55
CRICKET	500 / 0.5 / 50	300 / 0.5 / 50	200 / 0.3 / 55
CYCLE RACING	500 / 0.7 / 50	300 / 0.7 / 50	100 / 0.5 / 55
EQUESTRIAN	500 / 0.7 / 50	200 / 0.5 / 55	100 / 0.5 / 55
FOOTBALL (AMERICAN)	500 / 0.7 / 50	200 / 0.6 / 50	75 / 0.5 / 55
FOOTBALL	500 / 0.7 / 50	200 / 0.6 / 50	75 / 0.5 / 55
FOOTBALL (GAELIC)	300 / 0.7 / 50	250 / 0.6 / 50	75 / 0.5 / 55
GOLF DRIVING RANGE	-	-	100 / 0.8 / -
GREYHOUND RACING	300 / 0.7 / -	100 / 0.5 / -	-
HOCKEY	500 / 0.7 / 50	300 / 0.7 / 50	200 / 0.7 / 55
HORSE RACING	200 / 0.6 / 50	100 / 0.4 / 50	50 / 0.2 / 55
HURLING	500 / 0.7 / 50	350 / 0.7 / 50	200 / 0.5 / 55
ICE HOCKEY	750 / 0.7 / -	500 / 0.7 / -	200 / 0.5 / -
LAWN TENNIS	500 / 0.7 / 50	300 / 0.7 / 50	200 / 0.6 / 55
NETBALL	500 / 0.7 / 50	200 / 0.6 / 50	75 / 0.5 / 55
RUGBY	500 / 0.7 / 50	200 / 0.6 / 50	75 / 0.5 / 55
SKIING (ARTIFICIAL SLOPES)	-	-	100 / 0.5 / -
SPEED SKATING	500 / 0.7 / 50	200 / 0.5 / 55	100 / 0.5 / 55

MUGAs	CLUB - CLASS II (Lux / Ud / GR)	COMMUNITY - CLASS III (Lux / Ud / GR)
NETBALL	400 / 0.7 / 50	400 / 0.7 / 50
TENNIS PPA	500 / 0.7 / 50	500 / 0.7 / 50
TENNIS TPA	600 / 0.6 / 50	600 / 0.6 / 50
BEACH VOLLEYBALL	200 / 0.6 / -	75 / 0.5 / -
5-A-SIDE FOOTBALL	120 / 0.6 / 50	120 / 0.6 / 50
BASKETBALL	200 / 0.6 / 50	75 / 0.5 / 50
RUSH HOCKEY	350 / 0.7 / 50	200 / 0.7 / 50
SPEED SKATING	200 / 0.5 / 55	100 / 0.5 / 55

Asymmetric vs Symmetric Lighting

With Asymmetric Floodlights

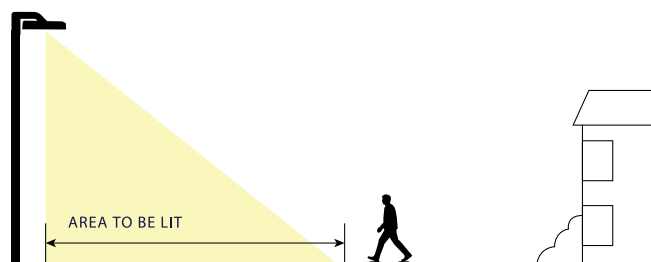

With Symmetric Floodlights

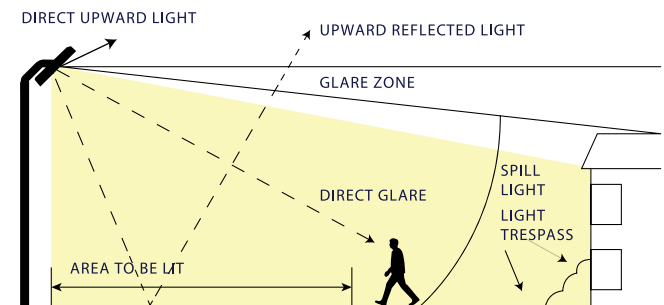





Indoor Sports Lowbay



A durable luminaire specifically designed for indoor sporting environments. The curved body shape minimises the chances of the sports equipment becoming stuck.



-  Material Construction:
- Body and wire guard - Mild steel
-  Wire guard included as standard
-  Multiple CCT options available on request
-  Surface/trunking mounting bracket included
-  Emergency and dimming available on request

Order No.	Model No.	Description	Wattage (W)	Lumens (lm)	Efficacy (lm/W)	Colour Temperature (K)
INDOOR SPORTS LOWBAY						
2503049299	HISL3-52-4K	Indoor Sports Lowbay	52	7228	139	4000K
2503049300	HISL3-83-4K	Indoor Sports Lowbay	83	11611	139	4000K
2503049301	HISL3-103-4K	Indoor Sports Lowbay	103	14409	139	4000K
2503049302	HISL3-128-4K	Indoor Sports Lowbay	128	17906	139	4000K
2503049303	HISL3-152-4K	Indoor Sports Lowbay	152	21264	139	4000K

09 | Street & Amenity



Scan here to see our
full range online



LED Street Light



5
YEAR
WARRANTY

IP66

IK10

Gator LED Street Lighting is ideal for lighting larger outdoor areas. Our Gator LED Street Lights are designed to be easy to install via toolless entry. The shorting cap can be replaced by a photocell sensor. Rotate and pivot the mount bracket to allow for vertical or horizontal fitment with no additional joints required. The Spigot size is 76mm and a Wall Bracket for these products is available. All models include a CTA switch allowing the product to change colour temperature between Warm White (3000K) Cool White (4000K) and Daylight (6000K).

- Material Construction:
Body - Powder Coated Aluminium
Diffuser - Glass
- CCT Switchable
- 76mm spigot diameter
- Can be fitted as post top or side entry
- 10kV surge protection
- Toolless entry
- See page 205-206 for compatible photocells



Order No.	Model No.	Description	Wattage (W)	Lumens (lm)	Efficacy (lm/W)	Colour Temperature (K)
LED STREET LIGHT						
2501464522	OV11320GY	20W LED Street Head	20	2800/3100/2800	3.66	3000/4000/6000K
2501464523	OV11340GY	40W LED Street Head	40	5600/6200/5600	3.66	3000/4000/6000K
2501464524	OV11365GY	65W LED Street Head	65	9100/10,050/9100	4.45	3000/4000/6000K
2501464520	OV113100GY	100W LED Street Head	100	14,000/15,500/14,000	4.45	3000/4000/6000K
2501464521	OV113135GY	135W LED Street Head	135	18,800/20,500/18,800	5.4	3000/4000/6000K
2503029993	OGC50	50mm Mounting Collar				
2503029994	OGC60	60mm Mounting Collar				
2501464526	OV113WB	Wall Mount Bracket				



Distinctive Products Outstanding Service

Explore our proven range of luminaires, built for reliability, efficiency, and long-term performance.

From contemporary bollards to powerful floodlights, our core products are trusted by contractors and specifiers across the UK. Whether it's a retail park, urban space, or industrial site, we deliver lighting solutions that meet the demands of today's environments.



LED Street Head

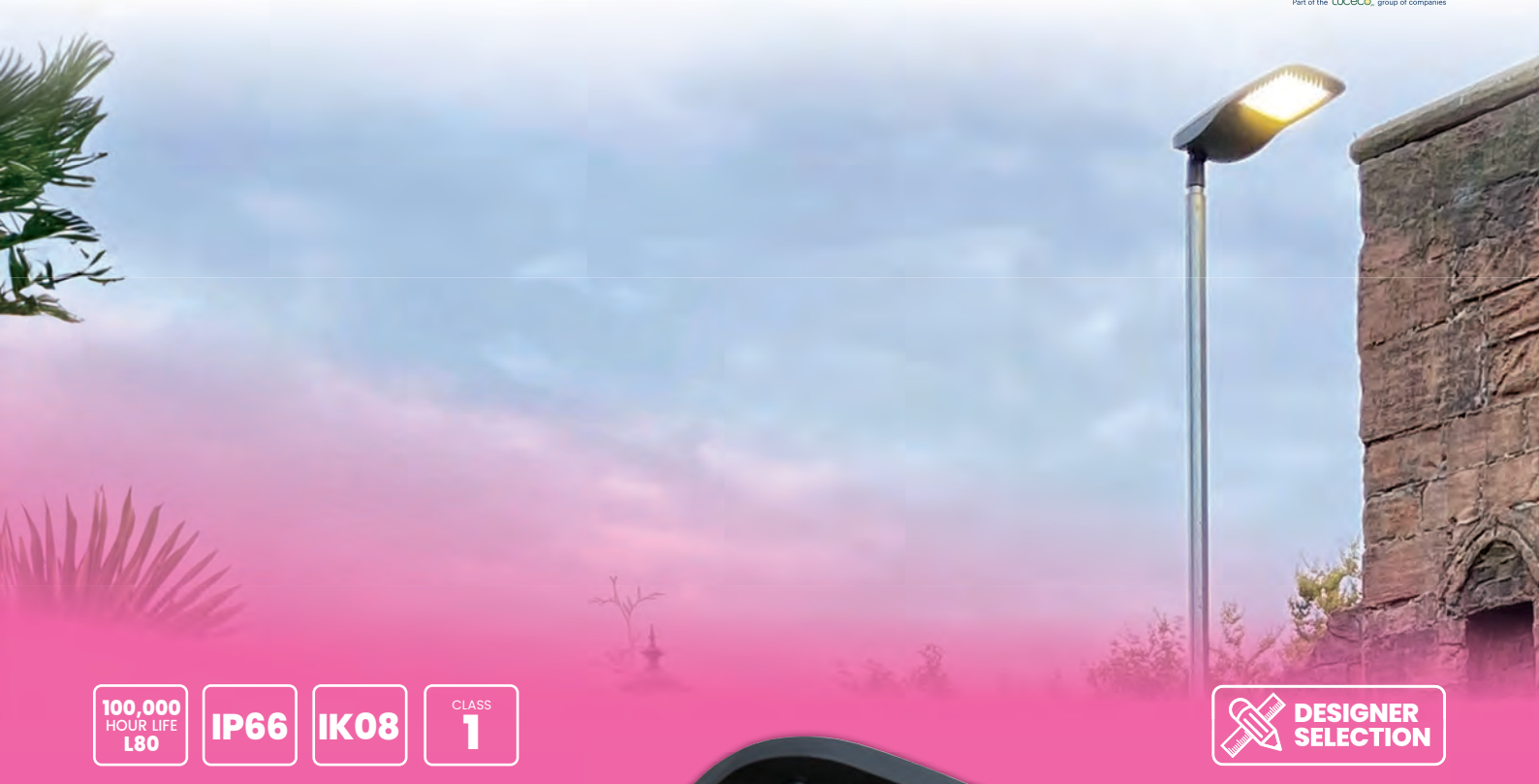

100,000
HOUR LIFE
L80

IP66





IK08

CLASS
1

DESIGNER
SELECTION

A modular, slimline, performance street lantern with improved efficacy and output. Viva-City Pro offers a choice of optics with asymmetrical distribution including an area optic.



-  Asymmetrical Forward Throw Optic - 70°
-  DALI Driver
-  Post top & side entry 60/76mm
-  Dimmable

Order No.	Model No.	Wattage (W)	Lumens (lm)	Finish/Colour	Colour Temperature (K)	Fitted Photocell
LED STREET HEAD						
2501602406	VCYP-FW70-4.10-40D-02	40	5880	Anthracite Grey	4000K	No
2501602407	VCYP-FW70-4.10-40DPEC-02	40	5880	Anthracite Grey	4000K	Yes
2501602408	VCYP-FW70-4.6-60D-02	60	8760	Anthracite Grey	4000K	No
2501602409	VCYP-FW70-4.6-60DPEC-02	60	8760	Anthracite Grey	4000K	Yes
2501602410	VCYP-FW70-4.8-80D-02	80	11040	Anthracite Grey	4000K	No
2501602412	VCYP-FW70-4.8-80DPEC-01	80	11040	Anthracite Grey	4000K	Yes
2501602735	VCYP-FW70-4-20-100D	20/40/60/80/100	2760-13,800	Anthracite Grey	4000K	No





Cireco LED Street Head



- 5
YEAR
WARRANTY
- 100,000
HOUR LIFE
- IP66
- IK08

Created with sustainability in mind, CIRECO has been designed surrounding the circular economy model and supports the ethos of 'reduce, reuse, recycle'. Utilising innovative LED technology this sleek luminaire is the perfect solution for illumination of street and pathway applications.







-  Material Body
Die-cast Aluminium
-  Asymmetric Street Optic 70°
-  Anthracite Grey (RAL7016) finish
-  2700K colour temperature available on request
-  Excellent sustainability option due to replaceable components

Order No.	Model No.	Description	Wattage (W)	Lumens (lm)	Efficacy (lm/W)	Colour Temperature (K)
CIRECO LED STREET HEAD						
2501602426	CIR-AY70-4.10-25D	Standard	25	3804	152	4000K
2501602427	CIR-AY70-4.10-25DPEC	Photocell	25	3804	152	4000K
2501602428	CIR-AY70-4.8-40D	Standard	40	5714	142	4000K
2501602429	CIR-AY70-4.8-40DPEC	Photocell	40	5714	142	4000K
2501602430	CIR-AY70-4.6-60D	Standard	60	9009	150	4000K
2501602431	CIR-AY70-4.6-60DPEC	Photocell	60	9009	150	4000K
2501602432	CIR-AY70-4.8-75D	Standard	75	10,925	145	4000K
2501602434	CIR-AY70-4.8-75DPEC	Photocell	75	10,925	145	4000K

Post Top Amenity Street Light



This classic amenity luminaire is made from robust die-cast aluminium and is perfect for a wide range of applications.

-  Symmetrical 90° optic prismatic diffuser
-  DALI Driver
-  Post Top 76mm
-  7.5kg
-  Dimmable



Order No.	Model No.	Wattage (W)	Lumens (lm)	Finish/Colour	Colour Temperature (K)	Fitted Photocell
POST TOP AMENITY STREET LIGHT						
2501602371	CIV40D-02	40	4400	Anthracite Grey	4000K	No
2501602372	CIV40DPEC-02	40	4400	Anthracite Grey	4000K	Yes
2501602373	CIV60D-02	60	6600	Anthracite Grey	4000K	No
2501602374	CIV60DPEC-02	60	6600	Anthracite Grey	4000K	Yes

Post Top Spherical Street Light



>50,000
HOUR LIFE
L70

IP65

IK10

A spherical luminaire with an effective light distribution, Sloane 2.0 is ideal for large area amenity applications.

-  Symmetrical distribution
-  76mm post top
-  Efficacy up to 73.0 lm/W
-  12.5 kg



Order No.	Model No.	Wattage (W)	Lumens (lm)	Finish/Colour	Colour Temperature (K)	Fitted Photocell
POST TOP SPHERICAL STREET LIGHT						
2501245415	SLOA35F	35	2520	Anthracite Grey	4000K	No
2501245416	SLOA35FPEC	35	2520	Anthracite Grey	4000K	Yes
2501245417	SLOA55F	55	4005	Anthracite Grey	4000K	No
2501245418	SLOA55FPEC	55	4005	Anthracite Grey	4000K	Yes

LED Bollard



50,000
HOUR LIFE







IP65

IK08

CLASS
1

 **DESIGNER
SELECTION**

Deco 2.0 is a robust bollard with a classic look suitable for most schemes. It comes with a switchable output and both emergency and photocell options. The effect is a comfortable, low-glare light output tailored for your site.

-  Radial distribution
-  Driver included
-  Flange mount
-  Adjustable output
-  5.7kg
-  180mm diameter



Order No.	Model No.	Height (mm)	Wattage (W)	Lumens (lm)	Finish/Colour	Colour Temperature (K)	Fitted Photocell	3 Hour Emergency
LED BOLLARD								
2501182085	DEC715	1040	7.5/15	930/1860	Anthracite Grey	4000K	No	No
2501245277	DEC715PEC	1040	7.5/15	930/1860	Anthracite Grey	4000K	Yes	No
2501182084	DEC715EM	1040	7.5/15	930/1860	Anthracite Grey	4000K	No	Yes
2501245275	DEC715EMPEC	1040	7.5/15	930/1860	Anthracite Grey	4000K	Yes	Yes

Modern LED Wallpack



100,000
HOUR LIFE
L80



IP66

IK10

CLASS
1

A stylish, modern bulkhead available with LED emergency and photocell. Quarto 2.0 is suited to building and perimeter lighting.



-  Asymmetrical street optic ST
-  4.0kg
-  Wall mounted
-  Wall pattress available
-  W:230 x H:230 x D:231mm

Order No.	Model No.	Wattage (W)	Lumens (lm)	Finish/Colour	Colour Temperature (K)	Fitted Photocell	3 Hour Emergency
MODERN LED WALLPACK							
2501602397	QUASTI5F	14.2	1620	Anthracite Grey	4000K	No	No
2501602398	QUASTI5FEM	14.2	1620	Anthracite Grey	4000K	No	Yes
2501602399	QUASTI5FEMPEC	14.2	1620	Anthracite Grey	4000K	Yes	Yes

Street Lighting Cutout



IP43

Suitable for column mounting, these fused cut-out units allow for the safe termination of incoming and outgoing PVC SWA cables and the fusing of the supply feed to the luminaire(s).



- Comes with 6A fuse(s)
- Brass plated terminal blocks
- Designed and tested to BS 7654 and IEC/EN60947-Part 1

Order No.	Model No.	Description
STREET LIGHTING CUTOUT		
1052080572	NLCOIP	Single Phase Street Lighting Cutout
1052080573	NLCO3P	Three Phase Street Lighting Cutout

Street Lighting Cutouts and Accessories



Order No.	Model No.	Description
STREET LIGHTING CUTOUT		
2501683070	THM0009901R	Twin Fuse Street Lighting Cutout with Brass Gland Plate
2501683075	THM0014962R	Single Fuse Double Pole Street Lighting Isolator
2501683068	THM0003209R	Short Extension Trough
2501683069	THM0022629R	Long Extension Trough

10 | Site, Temporary & Portable



Scan here to see our
full range online





Anti Corrosive Site Lights

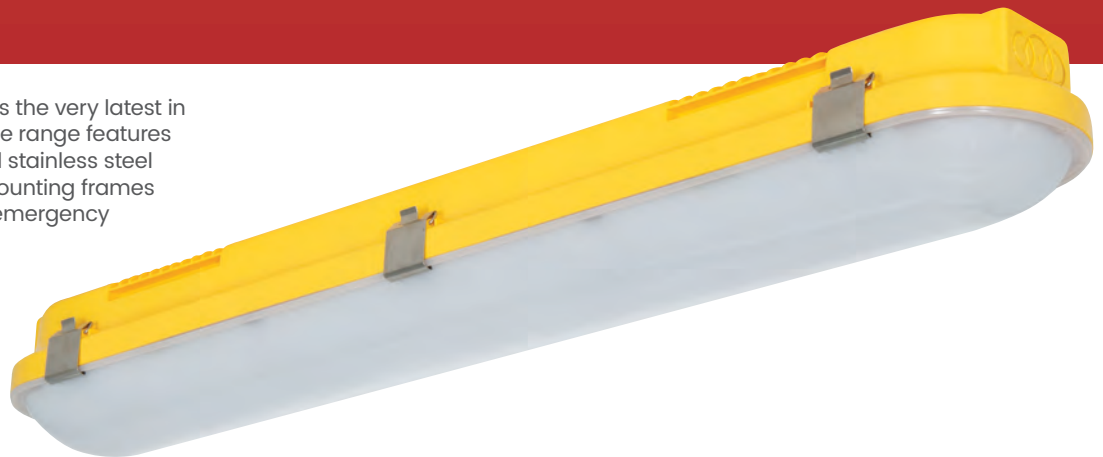

The new Sitio range from KSR offers the very latest in IP65 non-corrosive site lighting. The range features high efficiency up to 131lm/cW and stainless steel clips as standard, with optional mounting frames and a full range of standard and emergency variants also available.



-  Polycarbonate body construction with stainless steel clips
-  Optional mounting frames available (See opposite page)
-  BESA box mountable via brackets

Order No.	Model No.	Description	Wattage (w)	Colour Temp. (k)
ANTI CORROSIVE SITE LIGHTS				
2503031279	KSR5400	2ft Standard	19	4000K
2503031290	KSR5400/EM	2ft Emergency	19	4000K
2503031301	KSR5402	4ft Standard	19	4000K
2503031312	KSR5402/EM	4ft Emergency	19	4000K
2503031323	KSR5403	5ft Single Standard	24	4000K
2503031334	KSR5403/EM	5ft Single Emergency	24	4000K
2503031214	KSR5404	5ft Twin Standard	50	4000K
2503031225	KSR5404/EM	5ft Twin Emergency	50	4000K

Anti Corrosive Site Lights with Junction Box



3
YEAR
WARRANTY

IP65

IK08

- Polycarbonate body construction with stainless steel clips
- Optional mounting frames available (See below)
- Comes pre-wired with 1m cable and junction box
- BESA box mountable via brackets



Order No.	Model No.	Description	Wattage (w)	Colour Temp. (k)
ANTI CORROSIVE SITE LIGHTS WITH JUNCTION BOX				
2503031236	KSR5405	2ft Standard with Junction Box	19	4000K
2503031247	KSR5405/EM	2ft Emergency with Junction Box	19	4000K
2503031251	KSR5406	5ft Twin Standard with Junction Box	50	4000K
2503031252	KSR5406/EM	5ft Twin Emergency with Junction Box	50	4000K

Anti Corrosive Site Light Accessories



- Designed to work with KSR5400 2ft Anti Corrosive Site Lights
- Complete with twin 110V sockets
- Pre-wired with 5m cable and plug



Order No.	Model No.	Description
ANTI CORROSIVE SITE LIGHT ACCESSORIES		
2503031253	KSR5407	Tripod
2503031254	KSR5408	A-Frame

Dual Voltage Site Bulkheads



2
YEAR
WARRANTY

IP65

IK08

A range of multi-voltage (110–240V) bulkheads. Designed for use on construction site hoardings, scaffolding and general lighting, the range features a choice of opal, frosted clear or red diffusers.



- Polycarbonate construction
- Multiple cable entry points
- 160 degree beam angle

Order No.	Model No.	Description	Wattage (w)
DUAL VOLTAGE SITE BULKHEADS			
2503031270	KSR5426	Clear	8
2503031271	KSR5427	Opal	8
2503031272	KSR5428	Red	8

Site Globe Lights



2
YEAR
WARRANTY

IP44

IK08

The Site globe light features 360° light distribution and can be free standing, tripod mounted or suspended.

- Full polycarbonate construction
- Emergency variant available
- Adjustable height tripod accessory available separately
- Supplied with 16A IP44 plug and 3 metre lead
- Suspendable using in-built hook



Order No.	Model No.	Description	Wattage (w)	Colour Temp. (k)
SITE GLOBE LIGHTS				
2503031260	KSR5414	Standard	30	4000K
2503031261	KSR5415	Emergency	30	4000K
2503031262	KSR54196	Adjustable Tripod Base		

Site Festoon Kits



2
YEAR
WARRANTY

IP44

IK08

This new Site Festoon Kits are available in 15, 23m and 43m lengths and are fully interconnectable, up to a maximum of 200W total load. Kits are pre-wired with a 16A plug for fast connection to a 110V supply.

- Supplied with 16A IP44 plug
- Interconnectable up to a maximum of 200W load



Order No.	Model No.	Description	Wattage (w)	Colour Temp. (k)
SITE FESTOON KITS				
2503031255	KSR5410	15 Metre 6 Way	30	6500K
2503031256	KSR5411	23 Metre 10 Way	50	6500K
2503031258	KSR5412	43 Metre 20 Way	100	6500K
2503031259	KSR5413	Splitter Cable		

Site Floodlights



3
YEAR
WARRANTY

IP65

IK07

- Aluminium body with glass lens
- Supplied prewired with 1m cable
- 110 degree beam angle for wide distribution



Order No.	Model No.	Description	Wattage (W)	Lumens (lm)	Colour Temp. (K)
SITE FLOODLIGHTS					
2503031263	KSR5420	110V LED Site Floodlight	50	5365	4000K
2503031264	KSR5421	110V LED Site Floodlight	100	10730	4000K
2503031265	KSR5422	110V LED Site Floodlight	150	15890	4000K
2503031266	KSR5423	110V LED Site Floodlight	200	21760	4000K

Site Emergency Lights



- Polycarbonate construction
- Bulkhead can be used in maintained or non-maintained operation
- Twin spot is non-maintained only
- Bulkhead supplied complete with legends

2
YEAR
WARRANTY

IP65

IK08



Order No.	Model No.	Description	Wattage (W)	Colour Temp. (K)
SITE EMERGENCY LIGHTS				
2503031269	KSR5424	LED Bulkhead	4.5	6500K
2503031267	KSR5425	LED Twin Spot	4	6500K

Hand Held Site Lights



A versatile range of compact and lightweight worklights. Tripod mount options are supplied as a complete unit – tripod, mounting bracket and light heads – for convenience.

3
YEAR
WARRANTY

IP54

IK08





-  110V supply only
-  180 degree total tilt
-  Single headed light compatible with KSR5416 tripod
-  Pre-wired with 16A 3m cable and IP44 plug



Order No.	Model No.	Description	Wattage (w)	Colour Temp. (k)
HAND HELD SITE LIGHTS				
2503031273	KSR5430	15W Hand Held Site Light	15	6500K
2503031274	KSR5431	2x15W Hand Held Site Light & Tripod	30	6500K

Rechargeable Site Light



-  USB rechargeable (cable supplied)
-  USB charging requires 2A 5VDC connection
-  Flashing SOS mode feature lasting up to 48 hours
-  6 hour runtime at 60% output

3
YEAR
WARRANTY

IP65

IK08



Order No.	Model No.	Description	Wattage (w)	Colour Temp. (k)
RECHARGEABLE SITE LIGHT				
2503031275	KSR5432	Rechargeable Floodlight	20	6500K

Inspection & Worklights



Order No.	Model No.	Description	Wattage (w)	Lumens (lm)
INSPECTION & WORKLIGHTS				
2501138676	LILT15T65-02	USB Rechargeable Mini Tilt Torch	1.5	150
2501138674	LILT30R65-02	USB Rechargeable Swivel Tilt Torch with Power Bank	3	300
2503005092	LILT45T65-02	USB Rechargeable Swivel Tilt Torch with Power Bank	5	450
2501543320	LILTP60S65-01	USB Rechargeable Multifunctional Cage Worklight	10	600
2501346733	LWR7G65-01	USB Rechargeable Magnetic Work Light	7.5	750
2501468103	LILW100U65UC-02	USB-C Rechargeable High Output Inspection Torch	10	1000
2501587064	LILM13G65-01	Folding Magnetic Worklight	10	1300
2501587063	LILC10G65-01	Folding Clamp Worklight	10	1000
2501543321	LWHOA70G65-01	Open Area High Output Worklight with 13a Power Socket	66	7150
2503005093	LILH15P65-02	USB Rechargeable Head Torch with Motion Sensor	3	150
2501542738	LILHF35P65-01	USB Flexible Head Torch with Motion Sensor	5	350

11 | Coastal



Scan here to see our
full range online



LED Outdoor Bulkhead



A range of round and oval bulkheads. With the added flexibility of using the LED lamp in different colours or upgrading to a smart lamp.

1
YEAR
WARRANTY

IP44

- Material Construction:
Polypropylene Body
Frosted Diffuser
- Suitable for use in high saline coastal areas
- Lamp not included see page 170 onwards for options



Order No.	Model No.	Description
LED OUTDOOR BULKHEAD		
2501182940	KSR1505	Round Wall Bulkhead E27 Base
2501182941	KSR1506	Oval Wall Bulkhead E27 Base

GU10 Wall and Ground Lights



An outdoor range of exterior spotlights that complement each other including a spike light, round up light and a round up/down light. With the added flexibility of using the LED GU10 in different colours or upgrading to a smart lamp.

1
YEAR
WARRANTY

IP65
Wall Lights

IP44
Spike Lights

- Material Construction:
Body - Polypropylene black
Diffuser - Polycarbonate clear/glass
- Spike light supplied with 1m cable
- Polypropylene suitable for use in high saline coastal areas
- Lamp not included - 9W LED max, halogen not suitable see pages 178-179 for options



Order No.	Model No.	Description	Type
GU10 WALL AND GROUND LIGHTS			
2501182926	KSR1500BLK	GU10 Black Polypropylene Wall Light Down	Polypropylene
2501182927	KSR1501BLK	GU10 Black Polypropylene Wall Light Up/Down	Polypropylene
2501182928	KSR1504BLK	GU10 Black Polypropylene Spike Light Supplied with 1m Cable	Polypropylene

Bilbao Coastal Wall Lights

The Bilbao range consists of a 12W 4000K LED plain wall light with the option of changing the standard cover to either an up and down, louvred or eyelid. Ideal for high saline and coastal areas.



Material Construction:
Polycarbonate/ABS

CRI 84



Order No.	Model No.	Description	Wattage (W)	Lumens (lm)	Colour Temp. (K)
BILBAO COASTAL WALL LIGHTS					
2501138752	KSRI520	LED Plain Wall Light Dark Grey	12	940	4000K

Order No.	Model No.	Description
ACCESSORIES		
2501138753	KSRI521	Bilbao Louvre Cover only Dark Grey (Reduces Output to 668lm)
2501138754	KSRI522	Bilbao Up and Down Cover only Dark Grey (Reduces Output to 335lm)
2501138755	KSRI523	Bilbao Eyelid Cover only Dark Grey (Reduces Output to 629lm)

Norcia Coastal Wall Light

Suitable for use in high saline coastal areas. For use with retrofit GU10 LED lamps up to and including 9W.



Material Construction:
Polycarbonate/ABS

9W GU10 LED Max

Lamps not included,
see pages 178-179 for options



Order No.	Model No.	Description
NORCIA COASTAL WALL LIGHT		
2501138738	KSRI502BLK	GU10 Square IP65 Single Wall Light Black
2501138739	KSRI503BLK	GU10 Square IP65 Up and Down Wall Light Black

ReXEL

Denmans
REXEL GROUP

Ask us about our

MASSIVE Cable Offer

**Speak to a member of the team
in branch to find out more**

12 | Residential Indoor



Scan here to see our
full range online



LED Fire Rated Downlights



3
YEAR
WARRANTY

IP65

Introducing the brand new Newlec LED fire-rated downlight! With four colour temperature options to choose from ranging from 2700K to 6000K, this downlight will suit all applications. The NLFRDLED downlight is compatible with leading and trailing edge dimmers and features full IP65 protection from the front and a 3 year warranty for peace of mind.



- Mains/phase Dimmable
- Comes with 2-part connector for quick and easy installation
- 4CCT switchable
- White bezel included
- 72mm Cutout

Order No.	Model No.	Description	Wattage (W)	Lumens (lm)	Colour Temperature (K)
LED FIRE RATED DOWNLIGHTS					
2503034646	NLFRDLED-01	5W Colour Switchable LED Integrated Fire Rated Downlight	5	500-550	2700/3000/4000/6000K
2503034647	NLFRDLED/10-01	5W Colour Switchable LED Integrated Fire Rated Downlight (10 Pack)	5	500-550	2700/3000/4000/6000K

Order No.	Model No.	Description
ACCESSORIES		
2503034648	NLFRDBEZWH-01	White Bezel
2503034649	NLFRDBEZCH-01	Chrome Bezel
2503034650	NLFRDBEZSC-01	Satin Chrome Bezel
2503034651	NLFRDBEZMB-01	Matte Black Bezel

LED Fire Rated Downlight Wattage/Colour Selectable



5
YEAR
WARRANTY
50,000 Hours

IP65

LED Fire rated downlight multi wattage 4CCT.

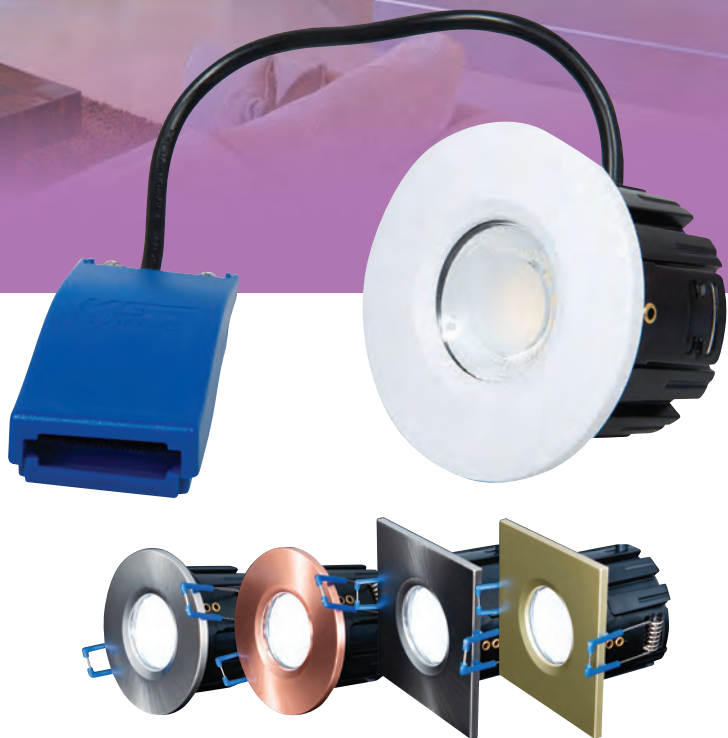

- Multi wattage 4CCT dimmable
- White bezel included - compatible with other QR bezels
- 72mm cutout
- Up to 820 lumens

Order No.	Model No.	Description	Wattage (W)	Lumens (lm)	Colour Temperature (K)
LED FIRE RATED DOWNLIGHTS					
2501431059	KSRFRD385	Firebreak QR Select II	5/7	560/590/640/635	2700/3000/4000/6000K
2501586749	KSRFRD386	Firebreak QR Pro with 2-Part Connector	5/7	560/590/640/635	2700/3000/4000/6000K
2503000342	KSRFRD386/10	Firebreak QR Pro with 2-Part Connector - Contractor Pack (10pcs)	5/7	560/590/640/635	2700/3000/4000/6000K

Order No.	Model No.	Description
ACCESSORIES		
2500873982	KSRFRD352	Chrome Bezel
2500873985	KSRFRD353	Satin Chrome Bezel
2500931931	KSRFRD355	Matte Black Bezel
2501586748	KSRFRD367	Satin Gold Bezel
2501377802	KSRFRD368	Copper Bezel
2500968734	KSRFRD369	Antique Brass Bezel
2501586751	KSRFRD390	Square White Bezel
2501586752	KSRFRD391	Square Chrome Bezel
2501586753	KSRFRD392	Square Satin Chrome Bezel
2501586754	KSRFRD393	Square Black Bezel
2501586755	KSRFRD394	Square Matte Gold Bezel







LED Fire Rated Downlight Wattage/Colour Selectable



5
YEAR
WARRANTY
50,000 Hours

IP65

This versatile fire rated downlight can be wattage & colour switched to either 2200, 2700K, 3000K or 4000K after installation. With a range of detachable bezels this is a fitting suitable for any application, both residential and commercial. With easy fit connector & fully insulation coverable.

-  Wattage and colour switchable
-  White bezel included
-  Solid Timber 30/60/90min, I-Joist 30min, Metal Web 30min ceiling joist approvals
-  68-72mm cutout, 55° Beam angle
-  TRIAC Mains dimmable
-  LENNEL style connector terminal block



Order No.	Model No.	Description	Wattage (w)	Efficacy (lm/w)	Colour Temperature (K)
LED FIRE RATED DOWNLIGHT WATTAGE/COLOUR SELECTABLE					
2503036163	DLT551500B	Switchable LED Fire Rated Downlight	4/6W	460-780	2200/2700/3000/4000K
2503036164	DLT551500B10	Switchable LED Fire Rated Downlight 10 Pack	4/6W	460-780	2200/2700/3000/4000K

Order No.	Model No.	Description
ACCESSORIES		
2500791904	RB359MW	Matte White Bezel Round
2500791899	RB359BLK	Matte Black Bezel Round
2500791901	RB359CR	Chrome Bezel Round
2500791900	RB359BS	Brushed Steel Bezel Round
2500791903	RB359SIL	Silver Bezel Round
2501465627	RB359AB	Antique Brass Bezel Round
2500791902	RB359PG	Polished Gold Bezel Round
2500791908	SQB360MW	Matte White Bezel Square
2500791907	SQB360BLK	Matte Black Bezel Square
2500791906	SQB360SIL	Silver Bezel Square
2500791910	SQB360PG	Polished Gold Bezel Square

LED PIR Integrated Downlight



5
YEAR
WARRANTY

IP65

CLASS
2

The Firebreak QR PIR Sensor LED downlight is a high performance fire-rated IP65 LED downlight with an integrated PIR sensor option, offering standard or PIR rims, the fitting can be used as a normal PIR or have master and slave (with appropriate rim) functionality, as well as normal fittings. Designed for energy efficiency and convenience, the 6W LED master PIR downlight can control up to 200W total load, making it an ideal solution for both residential and commercial applications alike.



- Can control up to 200W total load
- 72mm cutout
- Bezels need ordering separately
- 30min I-Joist and metal web

Order No.	Model No.	Description	Wattage (W)	Lumens (lm)	Colour Temperature (K)
LED PIR INTEGRATED DOWNLIGHT					
2503021121	KSRFRD340	Fire Rated PIR Sensor Downlight No Bezel	6	575-625	2700/3000/4000/6500K

Order No.	Model No.	Description
ACCESSORIES		
2503021122	KSRFRD341	White Bezel with PIR
2503021123	KSRFRD342	Black Bezel with PIR
2503021124	KSRFRD343	White Bezel without PIR
2503021125	KSRFRD344	Black Bezel without PIR

Order by 5pm for next day delivery



LED Mini Fire Rated Downlight



5
YEAR
WARRANTY

IP65

The New KSR Firebreak Qr, 5W, 3CCT & IP65 Mini LED Downlights at only 56mm overall diameter are perfect for downlighting any internal area. A mini version of the already widely known Firebreak Qr 5 downlights. They come with a 3CCT function which you can change the colour kelvin on the switch on the LED driver, phase dimmable as standard.



- Mains/phase dimmable
- CCT Switchable
- 42mm cutout
- Supplied with white bezel

Order No.	Model No.	Description	Wattage (W)	Lumens (lm)	Colour Temperature (K)
LED MINI FIRE RATED DOWNLIGHT					
2503000343	KSRFRD336	Fixed Downlight with White Bezel	5	355/395/490	2700/3000/4000K
2503000344	KSRFRD337	Baffle Downlight with White Bezel	5	175/200/265	2700/3000/4000K

Order No.	Model No.	Description
ACCESSORIES		
2503000345	KSRFRD338	Black Bezel

LED Fire Rated Downlight with 2-Part Fix







7
YEAR
WARRANTY
50,000 Hours

IP65

Representing the pinnacle of downlight technology today – specifically developed to streamline and help first-second fix installations, offering the very latest innovations for safety, ease of installation and testing compliance. Combining premium features, including wide 60° baffled back lens for reduced glare, with new innovative developments, from the QuickView window making it easier to inspect cables after locking lid shut, to the 500V VDE certified connection block, allowing installers to save time when 500V testing full installations.



-  Wattage switchable
-  500V insulation testing connector block
-  QuickView Cable Window for ease of inspection and safety
-  Choose between Dim2Warm and Colour Change models

Order No.	Model No.	Description	Wattage (W)	Colour Temperature (K)
LED FIRE RATED DOWNLIGHT WITH 2-PART FIX				
2503004948	PTF6WD2W-01	Dim to Warm	4/6W	3000/4000K
2503004947	PTR6WD2W-01	Regressed Dim to Warm	4/6W	3000/4000K
2503004949	PTA6WD2W-01	Adjustable Dim to Warm	4/6W	3000/4000K
2503004945	PTF6WCCT-01	CCT Switchable	4/6W	2700/3000/4000/6500K
2503004944	PTR6WCCT-01	Regressed CCT Switchable	4/6W	2700/3000/4000/6500K
2503004946	PTA6WCCT-01	Adjustable CCT Switchable	4/6W	2700/3000/4000/6000K

Order No.	Model No.	Description
ACCESSORIES		
2503005027	FT3EP24	Emergency Plug and Play Pack

DESIGNED FOR ENHANCED SAFETY

TITAN | ALL-IN-ONE from LUCECO



With advanced LiFePO4 battery, offering reliability, self test operation and 3 hour emergency lighting feature for enhanced safety.



Plug and Play
Microwave and Emergency packs for on-site adjustability.



5 Year Warranty
Tough and Durable
Engineered to last, backed by a 5 year warranty.



Self-Test Emergency
3 Hour emergency lighting feature.

For more information visit luceco.com/uk/titan-all-in-one

PROFESSIONAL LIGHTING FOR TRADE

YOU ASKED WE LISTENED

Designed with Contractors, for Contractors

FType
Elite
FLAWLESS FUNCTIONALITY



Simpler Options, Larger Choice

Available with 4 Colour CCT or Dim2Warm in Flat, Regressed or Adjustable with interchangeable bezels.

Built for Professionals
Fire-rated and Part L compliant.

QuickView™ window
For easy cable inspection with removable NELNEL terminal block, suitable for 500V testing.

Faster Installations
PushFit NELNEL terminal block and 1st/2nd fix ClipFit connector, streamline wiring and cable fastening.



For more information on our full range of FType Downlights scan the QR code



UK Patent: GB2628796

Fire Rated GU10 Downlight Can



1
YEAR
WARRANTY

IP20

IP65

CLASS
1



Our range of fire rated downlights offers a fully flexible solution for residential, retail or hospitality application. The bezels are quick and easy to install with a twist and lock mechanism allowing them to be removed as required for first fix or remedial works. The fire rated downlights are UK Building Regulations compliant to part B, C, E and L (depending on the lamp used).

- Fully fire rated 30, 60, 90 mins – Building Regulations Part B Compliant - Tested for use in Solid, I-Joist and Steel Open Web Joist ceilings
- Tool free push fit connector loop in/out for quick and easy connection
- Insulation coverable – fit and forget
- Spring clips – to minimise ceiling damage if removal required
- Lamps not included. See pages 178-179 for compatible lamps



Order No.	Model No.	Description
FIRE RATED GU10 DOWNLIGHT CAN		
2501097861	NLFRDGUI0	Fire Rated Can GU10

Order No.	Model No.	Description
ACCESSORIES		
2501097862	NLFRDWHI20	Trim White IP20
2501097863	NLFRDCHR20	Trim Chrome IP20
2501097864	NLFRDS/CHR20	Trim Satin Chrome IP20
2503043202	NLFRDBLK20	Matte Black Bezel IP20
2501097865	NLFRDWHI65	Trim White IP65
2501097866	NLFRDCHR65	Trim Chrome IP65
2501097867	NLFRDS/CHR65	Trim Satin Chrome IP65
2503043203	NLFRDBLK65	Matte Black Bezel IP65

240V GU10 Downlight Frame & Bezels



1
YEAR
WARRANTY

IP20

IP65

CLASS
1

Our range of GU10 downlights offers a fully flexible solution for residential, retail or hospitality application. The bezels are quick and easy to install with a twist and lock mechanism allowing them to be removed as required for first fix or remedial works.

- Tool free push fit connector loop in/out for quick and easy connection
- Spring clips – to minimise ceiling damage if removal required
- 72mm cut out

How to Order

- 1** Order the recessed frame and lamp holder
- 2** Order the required accessory



Shown with KSRDL425 white bezel with white baffle

Order No.	Model No.	Description
FIRE RATED GU10 DOWNLIGHT CAN		
2501182942	KSRDL400	Fixed Recessed Frame
2501182562	KSRDL401	Tilt Recessed Frame
2501182943	KSRDL402	Fixed GU10 Lampholder

240V GU10 Downlight Frame & Bezels



Order No.	Model No.	Description
IP20 BEZELS		
2501095137	KSRFRD401	White Bezel
2501095138	KSRFRD402	Chrome Bezel
2501095139	KSRFRD403	Satin Chrome Bezel
2501182602	KSRFRD407	Black Bezel
2501182603	KSRFRD408	Brass Bezel
2501377803	KSRFRD409	Copper Bezel
2501586756	KSRFRD420	Antique Brass Bezel
2501586757	KSRFRD421	Satin Brass Bezel

Order No.	Model No.	Description
TILT BEZELS		
2501095131	KSRFRD411	Tilt White Bezel
2501095132	KSRFRD412	Tilt Chrome Bezel
2501095133	KSRFRD413	Tilt Satin Chrome Bezel
2501182604	KSRFRD414	Tilt Black Bezel
2501377805	KSRFRD417	Tilt Copper Bezel
2501608957	KSRFRD422	Tilt Antique Brass Bezel
2501608958	KSRFRD423	Tilt Satin Brass Bezel



Order No.	Model No.	Description
IP65 BEZELS		
2501095140	KSRFRD404	White IP65 Bezel
2501095141	KSRFRD405	Chrome IP65 Bezel
2501095129	KSRFRD406	Satin Chrome IP65 Bezel
2501431061	KSRFRD419	Black IP65 Bezel

Order No.	Model No.	Description
BEZELS WITH BAFFLES		
2501182945	KSRDL425	White Bezel with White Baffle
2501182946	KSRDL426	White Bezel with Black Baffle
2501182947	KSRDL427	White Bezel with Chrome Baffle
2501182948	KSRDL428	White Bezel with Matte Gold Baffle
2501182949	KSRDL429	White Bezel with Rose Gold Baffle
2501182578	KSRDL430	Black Bezel with Black Baffle
2501182579	KSRDL431	Black Bezel with Chrome Baffle
2501182580	KSRDL432	Black Bezel with Matte Gold Baffle
2501182581	KSRDL433	Black Bezel with Rose Gold Baffle
2501182582	KSRDL434	Chrome Bezel with Black Baffle
2501182584	KSRDL435	Satin Chrome Bezel with Black Baffle







Order No.	Model No.	Description
WALL WASH		
2501182944	KSRDL420	White Rim Pin Wall Wash

Evofire Fire Rated GU10 Downlights



FIRE RATED
GLASS

Fire-rated technology downlights for every cut-out, every project, and every space. From large-scale architectural installations to compact residential settings, Evofire offers a comprehensive range of premium fire-rated glass downlights - all delivering a refined aesthetic and certified protection. Every Evofire product is independently fire tested and built with UK patented technology, exclusively from Integral LED, to elevate the look and performance of any lighting project.

-  Ultra thin 1mm blend-in bezel
-  Fire-rated glass technology to provide enhanced fire rating
-  Solid timber and I-joint compliant
-  Comes with GU10 lampholder & terminal block



Order No.	Model No.	Description	Cut Out (mm)
FIRE RATED 240V GU10 DOWNLIGHTS - 70MM CUT OUT			
2450015373	ILD LFR70D001	IP65 Fixed White	70
2500973392	ILD LFR70D001-4	IP65 Fixed White Pack of 4	70
2503012855	ILD LFR70K168	IP20 Tilttable White	70
2501020752	ILD LFR70D002	IP65 Fixed Satin Nickel	70
2503012854	ILD LFR70K169	IP20 Tilttable Satin Nickel	70
2450015395	ILD LFR70D017	IP65 Polished Chrome	70
2503012856	ILD LFR70K170	IP20 Tilttable Polished Chrome	70
2450017986	ILD LFR70D028	IP65 Fixed Black	70
2503012857	ILD LFR70K173	IP20 Tilttable Black	70
FIRE RATED 240V GU10 DOWNLIGHTS - 70-100MM CUT OUT			
2450015380	ILD LFR70D013	IP65 Fixed White	70-100
2503012859	ILD LFR70K182	IP20 Tilttable White	70-100
2450015390	ILD LFR70D014	IP65 Fixed Satin Nickel	70-100
2503012860	ILD LFR70K183	IP20 Tilttable Satin Nickel	70-100
2501133426	ILD LFR70D020	IP65 Fixed Polished Chrome	70-100
2503012861	ILD LFR70K184	IP20 Tilttable Polished Chrome	70-100

Evofire Fire Rated 240V MR11 Downlights



7
YEAR
WARRANTY

IP65



FIRE RATED
GLASS

Mini fire-rated downlight with a discreet appearance. Perfect for new build residential applications.

- 45mm cutout
- Ultra thin 1mm blend-in bezel
- 38.5mm super-low profile
- 30/60/90 minute fire-rated
- Lamp and lampholder not included see page 179 for compatible 35mm lamp
- Solid timber and I-joist compliant
- Standard GU10/MR16 size available on request



Order No.	Model No.	Description	Cut Out (mm)
FIRE RATED 240V GU10 DOWNLIGHTS			
2450017977	ILD LFR45D037	Mini Fire Rated Downlight White	45
2450017978	ILD LFR45D038	Mini Fire Rated Downlight Satin Nickel	45
2450017979	ILD LFR45D039	Mini Fire Rated Downlight Polished Chrome	45
2450069788	ILD LFR45D040	Mini Fire Rated Downlight Black	45

Order No.	Model No.	Description
ACCESSORIES		
2450068791	ILD LA001	GU10 Lampholder & Terminal Box with 300mm leads

Single Circuit Track & Accessories



1
YEAR
WARRANTY

TRACK &
ACCESSORIES

3
YEAR
WARRANTY

FITTINGS

IP20

CLASS
1

A range of hospitality, retail & residential environments.
Multiple track, fittings & accessories for adaptability.

- Single Circuit Track
- Black and white options available
- Full lighting designs available on request
- 16A maximum load



Order No.	Model No.	Description	Colour	Wattage (W)	Lumens (lm)	Colour Temperature (K)
SINGLE CIRCUIT TRACK FITTINGS						
2503000346	KSR6570BLK	Rosco GU10 Track Fitting	Black			
2503020007	KSR6570WH	Rosco GU10 Track Fitting	White			
2503000307	KSR6571BLK	Rosco LED Adjustable Beam 15-55° Track Fitting	Black	10	660-830	2700/3000/4000K
2503000347	KSR6571WH	Rosco LED Adjustable Beam 15-55° Track Fitting	White	10	660-830	2700/3000/4000K
2503000348	KSR6572BLK	Rosco Multi Wattage LED Track Fitting	Black	16/20/24	1370-2085	2700/3000/4000K
2503000349	KSR6572WH	Rosco Multi Wattage LED Track Fitting	White	16/20/24	1370-2085	2700/3000/4000K
2503000350	KSR6573BLK	Rosco Multi Wattage LED Track Fitting	Black	28/32/36	2145-3095	2700/3000/4000K
2503031212	KSR6573WH	Rosco Multi Wattage LED Track Fitting	White	28/32/36	2145-3095	2700/3000/4000K



Order No.	Model No.	Description
ESCALA PRO TRACK		
2501117671	KSR6500BLK	Escala Pro Mains Single Circuit 1120mm Track Black
2501117672	KSR6500WH	Escala Pro Mains Single Circuit 1120mm Track White
2501117673	KSR6501BLK	Escala Pro Mains Single Circuit 2340mm Track Black
2501117674	KSR6501WH	Escala Pro Mains Single Circuit 2340mm Track White
ESCALA PRO ACCESSORIES		
2501117675	KSR6502BLK	Escala Pro Mains Straight Connector with Power Black
2501117677	KSR6502WH	Escala Pro Mains Straight Connector with Power White
2501117678	KSR6503BLK	Escala Pro Mains Right Angle (L) & Straight Connector with Power Feed Black
2501117679	KSR6503WH	Escala Pro Mains Right Angle (L) & Straight Connector with Power Feed White
2501117680	KSR6504BLK	Escala Pro Mains Flexible Connector Black
2501117681	KSR6504WH	Escala Pro Mains Flexible Connector White
2501117682	KSR6505BLK	Escala Pro Mains Power Feed with Conduit Entry Black
2501117683	KSR6505WH	Escala Pro Mains Power Feed with Conduit Entry White
2501117684	KSR6506BLK	Escala Pro Mains Live End Black
2501117685	KSR6506WH	Escala Pro Mains Live End White
2501117689	KSR6508BLK	Escala Pro Mains Adaptor to Provide Power from Track to Pendants Black
2501117690	KSR6508WH	Escala Pro Mains Adaptor to Provide Power from Track to Pendants White
ESCALA PRO SUSPENSION KITS		
2501117691	KSR6509BLK	Escala Pro Mains Wire Suspension Kit (2M) Black
2501117692	KSR6509WH	Escala Pro Mains Wire Suspension Kit (2M) White
2501117693	KSR6510	Escala Pro Mains Suspension Kit for Suspended Ceilings
ESCALA PRO SURFACE ADAPTORS		
2501117694	KSR6511BLK	Escala Pro Mains Surface Adaptor for Track Fittings Black
2501117695	KSR6511WH	Escala Pro Mains Surface Adaptor for Track Fittings White

GU10 Spotlights







1
YEAR
WARRANTY

IP20

CLASS
1

A complete range of decorative spotlights which offers style to any residential property. Perfect for a lounge, kitchen or hallway, with the added flexibility of using LED GU10 lamps in different colours or upgrading to smart lamps.

-  Material Construction:
Matt White/Black - Aluminium
Chrome - Steel
-  Dimmable dependent on type of lamp
-  Track variants compatible with KSR single circuit track (see pages 130-131)
-  360° rotation & 180° tilt for directional lighting
-  Lamps not included, see pages 178-179 for options



Order No.	Model No.	Description
WHITE		
2501182950	KSR6260WH	GU10 Single Spotlight
2501182951	KSR6261WH	GU10 Two Bar Spotlight
2501182952	KSR6262WH	GU10 Three Bar Spotlight
2501182953	KSR6263WH	GU10 Three Plate Spotlight
2503020007	KSR6570WH	Single Circuit Track Spotlight
BLACK		
2501182850	KSR6260BLK	GU10 Single Spotlight
2501182852	KSR6261BLK	GU10 Two Bar Spotlight
2501182855	KSR6262BLK	GU10 Three Bar Spotlight
2501182857	KSR6263BLK	GU10 Three Plate Spotlight
2503000346	KSR6570BLK	Single Circuit Track Spotlight
CHROME		
2500605248	KSR6220CH	GU10 Single Spotlight
2500605249	KSR6221CH	GU10 Two Bar Spotlight
2500605250	KSR6222CH	GU10 Three Bar Spotlight
2500605251	KSR6223CH	GU10 Four Bar Spotlight

Decorative Shades & Pendants



Lamps not included – see page 168 onwards for options

Order No.	Model No.	Description
CARLOTA		
2501508457	KSR1650BLK	Carlota E27 Single Pendant Matt Black with 1.2m Cable
2501508456	KSR1650SC	Carlota E27 Single Pendant Satin Chrome with 1.2m Cable
2501508455	KSR1650WH	Carlota E27 Single Pendant Matt White with 1.2m Cable



Order No.	Model No.	Description
OLIVERA		
2501508454	KSR1651BLK/COP	Olivera Large Lamp Shade Black / Copper Only
2501508453	KSR1651GRY/COP	Olivera Large Lamp Shade Grey / Copper Only

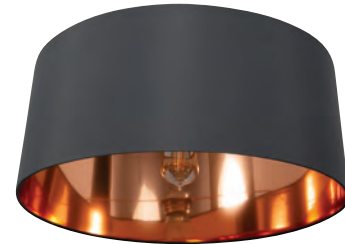

Order No.	Model No.	Description
MEDINA		
2501508452	KSR1652BLK	Medina Black Shade Only
2501508451	KSR1652COP	Medina Copper Shade Only
2501508449	KSR1652SC	Medina Satin Chrome Shade Only
2501508448	KSR1652WH	Medina White Shade Only



Order No.	Model No.	Description
PALMERA		
2501508447	KSR1653	Palmera Glass Shade Only

Order No.	Model No.	Description
SERENA		
2501508446	KSR1654	Serena Copper Glass Shade Only

Order No.	Model No.	Description
SANTONA		
2501508445	KSR1655	Santona Tear Drop Glass Shade Only



Order No.	Model No.	Description
VITORIA		
2501508444	KSR1660SC	Vitoria Single Glass E14 Wall Light Satin Chrome
2501508443	KSR1661SC	Vitoria Single E27 Glass Pendant Satin Chrome
2501508442	KSR1662SC	Vitoria 3 Light E14 Glass Pendant Satin Chrome



Order No.	Model No.	Description
ARCOS		
2501508441	KSR1665BLK	Arcos Square Glass E27 Hanging Lantern Black
2501508440	KSR1665WH	Arcos Square Glass E27 Hanging Lantern White
2501508553	KSR1667	Arcos E27 4 Light Pendant Light Black



Order No.	Model No.	Description
CONTEMPORARY METAL PENDANTS		
2503031389	KSR1656ANT	Antique Brass
2503031357	KSR1656BLK	Matte Black
2503031346	KSR1656BC	Brushed Chrome
2503031363	KSR1656WH	Matte White

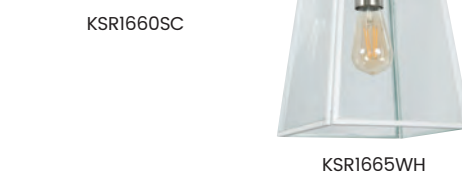



Linkable LED Undershef Lights



The Morini CCT LED undershef lights are ideal for lighting under shelves and under kitchen cabinets to illuminate shelves and working surfaces. Complete with mains power lead and fixing brackets. Can be linked either by plugging directly into the previous fitting or using an optional link lead.



-  Material construction
Polycarbonate body and diffuser
-  Linkable with the use of various length link leads
-  CCT switchable





Order No.	Model No.	Description	Wattage (w)	Length (mm)	Colour Temp. (k)
LINKABLE LED UNDERSHELF LIGHTS					
2501311921	KSRCL194	CCT LED Undershef Light	3	250	3000/4000K
2501182543	KSRCL195	CCT LED Undershef Light	4	344	3000/4000K
2501182544	KSRCL196	CCT LED Undershef Light	7	571	3000/4000K
2501182545	KSRCL197	CCT LED Undershef Light	14	905	3000/4000K
2501182546	KSRCL198	CCT LED Undershef Light	18	1205	3000/4000K
2500543053	KSRCL144WHT	150mm Link Lead			
2500543054	KSRCL145WHT	300mm Link Lead			
2500543055	KSRCL146WHT	500mm Link Lead			
2501311920	KSRCL147WHT	1000mm Link Lead			

Indoor Domestic Battens



Indoor domestic battens, perfect for loft, garage, shed, under-stair cupboard etc installations. Lightweight and prewired for quick and easy installation.



-  CCT switchable
-  Pre-wired



Order No.	Model No.	Description	Wattage (w)	Colour Temp. (k)
INDOOR DOMESTIC BATTENS				
2501674376	8405201331	600mm	20	3000/4000/6500K
2501674377	8405202331	1200mm	40	3000/4000/6500K
2501674378	8405203331	1500mm	50	3000/4000/6500K
2501674379	8405204331	1800mm	60	3000/4000/6500K

LED Under Cabinet Lights



240V LED Cabinet / Under shelf lights are ideal for a multitude of lighting applications where display or accent lighting is required. Round version can be surface mounted or recessed and all versions are complete with 1 metre of 2 core cable.

3
YEAR
WARRANTY

IP20

CLASS
2

- Material construction:
Polycarbonate body and diffuser
- CCT Switchable
- 240V supply - no driver required

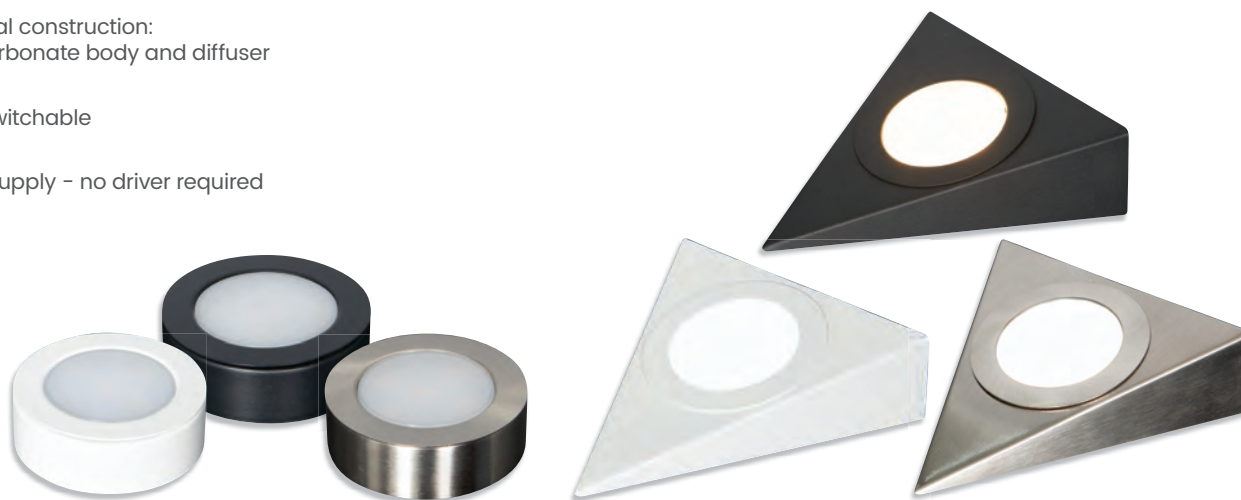

Order No.	Model No.	Description	Wattage (w)	Lumens (lm)	Colour Temp. (k)
LED UNDER CABINET LIGHTS					
2501608941	KSRCL205BLK	Circular Black	2.5	245	3000/4000/6000K
2501608942	KSRCL205SC	Circular Satin Chrome	2.5	245	3000/4000/6000K
2501608943	KSRCL205WH	Circular White	2.5	245	3000/4000/6000K
2501608944	KSRCL206BLK	Triangular Black	2.5	245	3000/4000/6000K
2501608945	KSRCL206SC	Triangular Satin Chrome	2.5	245	3000/4000/6000K
2501608946	KSRCL206WH	Triangular White	2.5	245	3000/4000/6000K

LED Plinth Lights



- Material construction:
Housing - Thermoplastic
Lens - Clear polycarbonate
- 26mm diameter cutout
- Requires 12V DC LED driver



1
YEAR
WARRANTY

IP44

Order No.	Model No.	Description	Wattage (w)	Colour Temp. (k)
INDOOR DOMESTIC BATTENS				
2501263118	OV204DLWH	White	0.8	6000K
2501263117	OV204DLSC	Satin Chrome	0.8	6000K
2501263116	OV204DLCH	Chrome	0.8	6000K
2501263083	OVTR301	12V LED Driver for 1-15 Plinth Lights		



LED Shaverlight

ENLITE®

Designed to withstand bathroom conditions, this shaver light boasts an IP44 rating, making it suitable for use in wet areas. Its IK08 rating ensures impact resistance, guaranteeing its durability with an impressive lifetime of 50,000 hours.

2
YEAR
WARRANTY
50,000 Hours

IP44

-  Dual voltage 110V - 220V
-  CCT Switchable
-  Non dimmable



Order No.	Model No.	Description	Wattage (W)	Lumens (lm)	Efficacy (lm/W)	Colour Temp. (K)
LED SHAVERLIGHT						
2501615426	SV1	Dual Voltage Shaver Light	8	1040	130	3000/4000/6000K

LED Shaverlight



ROBUS®

Smooth white finish polycarbonate body provides a easy to wipe clean to retain 'as-new' aesthetic. Opal diffuser with built in prisms provides maximum light is transmitted through the diffuser, and reduced glare.

3
YEAR
WARRANTY
30,000 Hours

IP44

NEW

-  CCT Selectable and Built-In Dimming Functionality
-  Dual voltage outputs of 230V & 115V
-  Suitable for installation outside of bathroom zones 1 & 2

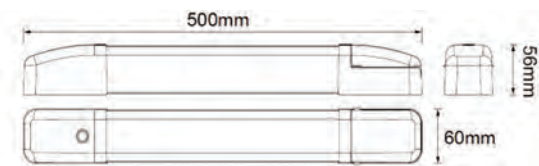

Order No.	Model No.	Description	Wattage (W)	Lumens (lm)	Colour Temp. (K)
LED SHAVERLIGHT					
2503038222	RSHIOLED-01	White Shaver Light	10	1180	3000/4000/6500K

13 | Residential Outdoor



Scan here to see our
full range online



LED Residential Floodlights



5
YEAR
WARRANTY
35,000 Hours

IP65

IK08

Outdoor LED floodlights suitable for a wide range of applications such as lighting façades, commercial or industrial areas, car parks, etc.

 Material Construction:
Aluminium body
Frosted glass diffuser

 Operating temperature -40°C to 50°C



Order No.	Model No.	Description	CRI	Wattage (W)	Dimensions WxLxH (mm)	Lumens (lm)	Colour Temp. (K)
LED RESIDENTIAL FLOODLIGHTS							
2501598892	911401854485	LED Floodlight	80	10	102 x 107 x 28	850	4000K
2501598890	911401854685	LED Floodlight	80	20	125 x 140 x 29	1700	4000K
2501598906	911401854885	LED Floodlight	80	30	161 x 185 x 28	2550	4000K
2501598904	911401855085	LED Floodlight	80	50	183 x 223 x 31	4250	4000K
2501665847	911401858185	LED Floodlight	80	70	217 x 276 x 31	5950	4000K
2501665851	911401858285	LED Floodlight	80	100	256 x 324 x 38	8500	4000K
2501665852	911401858385	LED Floodlight	80	150	298 x 385 x 41	12,750	4000K
2501665853	911401858485	LED Floodlight	80	200	342 x 452 x 45	17,000	4000K

Order No.	Model No.	Description	CRI	Wattage (W)	Dimensions WxLxH (mm)	Lumens (lm)	Colour Temp. (K)
LED RESIDENTIAL FLOODLIGHTS - PIR							
2501598891	911401854585	LED Floodlight PIR	80	10	137 x 107 x 58	850	4000K
2501598889	911401854785	LED Floodlight PIR	80	20	153 x 140 x 54	1700	4000K
2501598905	911401854985	LED Floodlight PIR	80	30	183 x 185 x 56	2550	4000K
2501598894	911401855185	LED Floodlight PIR	80	50	210 x 223 x 57	4250	4000K





CCT Switchable Residential LED Floodlight

5
YEAR
WARRANTY
50,000 Hours

3
YEAR
WARRANTY
PIR Sensors

IP65

Flicker-free floodlight ideal for outdoor use, lighting large areas, courtyards and entrances or for uplighting trees and buildings. With a market leading efficacy and contemporary black, anthracite or white cast aluminium body, this colour switchable light is a versatile solution for your space. Choose the PIR sensor option for added security and reduction of energy bills in highly trafficked areas.

-  Material Construction
Body: Cast aluminium
-  Pre-wired with 1m H05RN-F cable
-  Colour temperature switchable between 3000, 4000 & 6500K
-  120° Beam angle
-  360° rotation and 180° tilt for total flexibility



Order No.	Model No.	Description	Wattage (W)	Lumens (lm)	Efficacy (lm/W)	Finish/Colour	Colour Temp. (K)
PREMIUM RESIDENTIAL LED FLOODLIGHTS – NON-PIR							
2501159055	FLO1BXCS	10W Colour Switchable Floodlight	10	1100/1150/1300	110	Black	3000/4000/6500K
2501600231	FLO1AXCS	10W Colour Switchable Floodlight	10	1100/1150/1300	115	Anthracite	3000/4000/6500K
2501600227	FLO1WXCS	10W Colour Switchable Floodlight	10	1100/1150/1300	130	White	3000/4000/6500K
2501159057	FLO2BXCS	20W Colour Switchable Floodlight	20	2200/2400/2400	110	Black	3000/4000/6500K
2501600232	FLO2AXCS	20W Colour Switchable Floodlight	20	2200/2400/2400	120	Anthracite	3000/4000/6500K
2501600228	FLO2WXCS	20W Colour Switchable Floodlight	20	2200/2400/2400	120	White	3000/4000/6500K
2501159059	FLO3BXCS	30W Colour Switchable Floodlight	30	3000/3300/3900	100	Black	3000/4000/6500K
2501600233	FLO3AXCS	30W Colour Switchable Floodlight	30	3000/3300/3900	110	Anthracite	3000/4000/6500K
2501600229	FLO3WXCS	30W Colour Switchable Floodlight	30	3000/3300/3900	130	White	3000/4000/6500K
2501159061	FLO5BXCS	50W Colour Switchable Floodlight	50	5000/5600/5100	100	Black	3000/4000/6500K
2501600234	FLO5AXCS	50W Colour Switchable Floodlight	50	5000/5600/5100	112	Anthracite	3000/4000/6500K
2501600230	FLO5WXCS	50W Colour Switchable Floodlight	50	5000/5600/5100	102	White	3000/4000/6500K

Order No.	Model No.	Description	Wattage (W)	Lumens (lm)	Efficacy (lm/W)	Finish/Colour	Colour Temp. (K)
PREMIUM RESIDENTIAL LED FLOODLIGHTS – PIR							
2501159056	FLO1BPCS	10W Colour Switchable Floodlight	10	1100/1150/1300	110	Black	3000/4000/6500K
2501615089	FLO1APCS	10W Colour Switchable Floodlight	10	1100/1150/1300	115	Anthracite	3000/4000/6500K
2501615085	FLO1WPCS	10W Colour Switchable Floodlight	10	1100/1150/1300	130	White	3000/4000/6500K
2501159058	FLO2BPCS	20W Colour Switchable Floodlight	20	2200/2400/2400	110	Black	3000/4000/6500K
2501615090	FLO2APCS	20W Colour Switchable Floodlight	20	2200/2400/2400	120	Anthracite	3000/4000/6500K
2501615086	FLO2WPCS	20W Colour Switchable Floodlight	20	2200/2400/2400	120	White	3000/4000/6500K
2501159060	FLO3BPCS	30W Colour Switchable Floodlight	30	3000/3300/3900	100	Black	3000/4000/6500K
2501615091	FLO3APCS	30W Colour Switchable Floodlight	30	3000/3300/3900	110	Anthracite	3000/4000/6500K
2501615087	FLO3WPCS	30W Colour Switchable Floodlight	30	3000/3300/3900	130	White	3000/4000/6500K
2501159062	FLO5BPCS	50W Colour Switchable Floodlight	50	5000/5600/5100	100	Black	3000/4000/6500K
2501615092	FLO5APCS	50W Colour Switchable Floodlight	50	5000/5600/5100	112	Anthracite	3000/4000/6500K
2501615088	FLO5WPCS	50W Colour Switchable Floodlight	50	5000/5600/5100	102	White	3000/4000/6500K

Order by 5pm for next day delivery

GU10 Wall and Ground Lights



Spike Lights

Wall Lights

An outdoor range of exterior spotlights that complement each other including a spike light, round up light and a round up/down light. With the added flexibility of using the LED GU10 in different colours or upgrading to a smart lamp.



Material Construction:
 Body - 304 Stainless Steel
 Diffuser - Glass
 316 Stainless Steel variant available

Spike light supplied with 2m cable

Lamp not included - 9W LED max, halogen not suitable

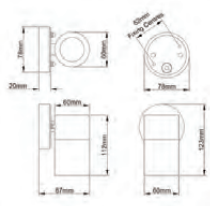

KSR13100

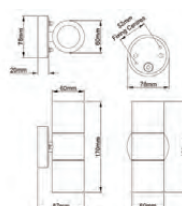

KSR13103



KSR13112

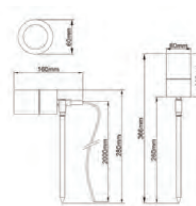

KSR13109

Order No.	Model No.	Description	Finish
GU10 WALL AND GROUND LIGHTS			
2501608966	KSR13100	GU10 Wall Light Down	Black
2501608969	KSR13103	GU10 Wall Light Up/Down	Black
2501608979	KSR13112	GU10 Wall Light Down & PIR	Black
2501608982	KSR13115	GU10 Wall Light Up/Down & PIR	Black
2501608976	KSR13109	GU10 Spike Light Supplied with 2m Cable	Black
2501608968	KSR13102	GU10 Wall Light Down	Stainless Steel
2501608971	KSR13105	GU10 Wall Light Up/Down	Stainless Steel
2501608981	KSR13114	GU10 Wall Light Down & PIR	Stainless Steel
2501608985	KSR13117	GU10 Wall Light Up/Down & PIR	Stainless Steel
2501608978	KSR13111	GU10 Spike Light Supplied with 2m Cable	Stainless Steel
2501608967	KSR13101	GU10 Wall Light Down	Copper
2501608970	KSR13104	GU10 Wall Light Up/Down	Copper
2501608980	KSR13113	GU10 Wall Light Down & PIR	Copper
2501608984	KSR13116	GU10 Wall Light Up/Down & PIR	Copper
2501608977	KSR13110	GU10 Spike Light with 2m Cable	Copper

GU10 Up/Down Lights



5
YEAR
WARRANTY

IP44

Modern wall light FOCUS is the ideal light next to your front door. A real eye-catcher. This light provides excellent lighting and casts light both up and down the wall.

 Material Construction:
Body - Heavy-duty aluminium
or stainless steel
Diffuser - Clear polycarbonate

 Lamps not included, see pages 178-179
for lamps

 Matching bollard available, see page 154



Order No.	Model No.	Description	Finish
GU10 UP/DOWN LIGHTS			
2503038248	5604011012	Standard	Black
2501457065	5604011118	Standard	Anthracite
2501634439	5604021001	Standard	Stainless Steel
2501634437	5604023118	Dusk/Dawn	Anthracite
2501674900	5604023012	Dusk/Dawn	Black
2503038249	5604014012	PIR	Black
2501634436	5604014118	PIR	Anthracite
2503024062	5604024001	PIR	Stainless Steel



Anti-Glare Residential Floodlight



5
YEAR
WARRANTY

IP54

The ATLANTIS Outdoor LED wall light, available in dark grey, features honeycomb clear PC diffusers. This versatile light comes in both small and larger versions.

-  Material Construction
- Body: Heavy duty aluminium
-  Unique anti-glare honeycomb construction
-  80° of tilt adjustment

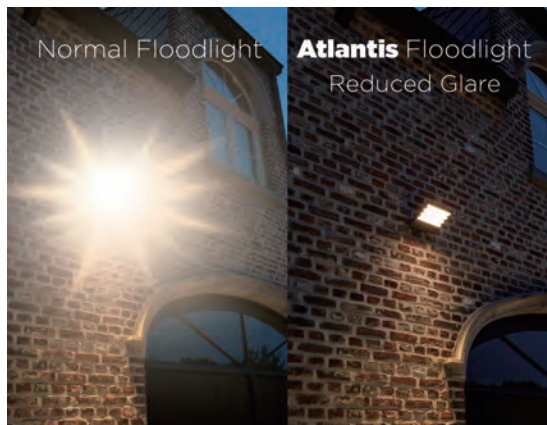

Order No.	Model No.	Description	Wattage (W)	Lumens (lm)	Finish/Colour	Colour Temp. (K)
ANTI-GLARE RESIDENTIAL FLOODLIGHT						
2503024058	7801601118	Standard	14	2000	Anthracite	4000K
2503024059	7801602118	PIR Sensor	14	2000	Anthracite	4000K
2503024060	7801603118	Standard	24	3200	Anthracite	4000K
2503024061	7801604118	PIR Sensor	24	3200	Anthracite	4000K

LED Twin Head Polycarbonate Floodlight



LUTEC

5
YEAR
WARRANTY

IP54

The Chimera outdoor LED security light features a 5000K floodlight for bright, clear illumination. It includes two adjustable heads with individual rotation, allowing precise directional lighting. An adjustable PIR sensor improves its functionality, making it a robust choice for comprehensive outdoor security and visibility.



-  Material Construction:
Body - Polycarbonate
Diffuser - Clear polycarbonate
-  PIR version lux, time and distance adjustable
-  15m detection range on PIR version

Order No.	Model No.	Description	Wattage (W)	Lumens (lm)	Colour Temp. (K)
LED TWIN HEAD POLYCARBONATE FLOODLIGHT					
2503024071	7635434330	Standard	21	2350	5000K
2503024072	7635432330	PIR	21	2350	5000K

LED Twin Head Aluminium Floodlight



LUTEC

5
YEAR
WARRANTY

IP54

Elegant yet powerful security floodlight with typical "bike lamp" design.



-  Material Construction:
Body - Heavy-duty aluminium
Diffuser - Clear polycarbonate
-  PIR version lux, time and distance adjustable
-  10m detection range on PIR version

Order No.	Model No.	Description	Wattage (W)	Lumens (lm)	Colour Temp. (K)
LED TWIN HEAD ALUMINIUM FLOODLIGHT					
2501634444	7622221012	Standard	23.5	2450	4000K
2501627414	7622222012	PIR	23.5	2450	4000K

Wall & Coach Lanterns – Black



A range of stylish lanterns available in the traditional 6 sided shape for retrofit or a 4 sided lantern for a more modern look. With the added flexibility of using LED lamps in different colours or upgrading to a smart lamp.

1
YEAR
WARRANTY

IP44

CLASS
2

- Material Construction:
Polypropylene body
Opal polycarbonate diffuser
- Can be used either upward or downward
(Non-PIR version)
- PIR Option available for added energy saving
- Lamp not included – see page 170
onwards for options



Order No.	Model No.	Description	Sides
WALL & COACH LANTERNS – BLACK			
2501182920	KSR1510BLK	E27 Lantern Up/Down	4
2501182921	KSR1511BLK	E27 Lantern PIR	4
2501182922	KSR1514BLK	E27 Lantern Up/Down	6
2501182923	KSR1515BLK	E27 Lantern PIR	6
2501182924	KSR1158BLK	E27 Black Lantern	Coach
2501182925	KSR1159BLK	E27 Black Lantern PIR	Coach

LED Brick Lights



The Madrid LED recessed wall lights are ideal for low level recessed wall lighting for illuminating paths, patios, decking, etc.

2
YEAR
WARRANTY
25,000 Hours

IP44

- Material construction
Body – Aluminium
Rim – Stainless Steel
Lens – Glass



Order No.	Model No.	Description	Wattage (W)	Lumens (lm)	Colour Temp. (K)
LED BRICK LIGHTS					
2501117593	KSR1350	LED Bricklight with Plain Frame Black	6	138 (84 if grille used)	3000K
2501117604	KSR1351	LED Bricklight with Plain Frame Black	6	138 (84 if grille used)	4000K
2501117615	KSR1352	LED Bricklight with Plain Frame Stainless Steel	6	138 (84 if grille used)	3000K
2501117626	KSR1353	LED Bricklight with Plain Frame Stainless Steel	6	138 (84 if grille used)	4000K

Order No.	Model No.	Description
ACCESSORIES		
2501117637	KSR1354	Black Grille Frame Only
2501117648	KSR1355	Stainless Steel Grille Frame Only

Contemporary Wall Lanterns



1
YEAR
WARRANTY

IP44

Decorative outdoor lanterns with a contemporary look and feel. Supplied without lamps to enable customers to customise to their own taste, or upgrade to Smart lamps.



2501597971



2501597973



2501597974

 Material Construction:
Body - Aluminium
Lens - Clear Glass

 Suitable for E27 LED lamps -
See page 170 onwards



2501597975



2501597976



2501597978



Order No.	Model No.	Description
CONTEMPORARY WALL LANTERNS		
2501597971	KSRI930	Single Wall Lantern
2501597972	KSRI931	Twin Wall Lantern
2501597973	KSRI932	Single PIR Wall Lantern
2501597974	KSRI933	Single Wall Lantern
2501597975	KSRI934	Small Wall Lantern
2501597976	KSRI935	Large Wall Lantern
2501597978	KSRI936	Large Wall Lantern

Track your orders and receive notifications



Modern Linear Wall Light

The simple yet striking LEO wall light. Featuring a strong up & down light beam and an opal vertical light strip in the front. The visual impact of this stunning modern LED fitting is especially impactful when multiple lights are installed in arrangement.

-  Heavy duty aluminium construction with opal polycarbonate diffuser
-  Also available in matt black



LUTEC

5
YEAR
WARRANTY



IP54

NEW

Order No.	Model No.	Description	Wattage (W)	Lumens (lm)	Colour Temp. (K)
MODERN LINEAR WALL LIGHT					
2501457063	5192701335	Dark Grey Wall Light	14.5	1600	3000K

Rust Effect Wall Lantern

The CATE series offers a complete family of lighting solutions that bring an authentic, cozy, and warm atmosphere to any outdoor space. Designed for filament retrofit bulbs, this versatile collection includes a wall light, a bollard, and a three-light lantern, each contributing to a charming and inviting environment.

-  Heavy duty aluminium construction with clear glass diffuser
-  Lamp not included - see page 170 onwards



LUTEC

5
YEAR
WARRANTY

IP44

NEW

Order No.	Model No.	Description
RUST EFFECT WALL LANTERN		
2501457089	5264201213	Black Rust Lantern
2503024057	5264207213	Black Rust Lantern with PIR

Compact LED Security Bulkhead



This bulkhead light is both compact and robust. The powerful LED light source can reduce running costs to just 10% vs traditional light sources. With an IP55 weatherproof rating and aesthetic modern styling this is a must for outdoor use where energy saving and security are paramount.

3
YEAR
WARRANTY

IP55

WHILE STOCKS LAST



- Material construction:
Polycarbonate body and diffuser
- Prismatic lens
- PIR version has adjustable time and light levels

Order No.	Model No.	Description	Wattage (W)	Lumens (lm)	Colour Temp. (K)
COMPACT LED SECURITY BULKHEAD					
2501009932	NLLRB3	Standard	5	350	4000K
2501009933	NLLRB3PIR	PIR	5	350	4000K

LED Residential Outdoor Bulkhead



Designed for versatility and durability, the Latina NR Select bulkheads are available in both oval or round versions & with or without PIR, offering a robust and stylish lighting solution for a variety of external applications. Perfect for residential spaces, the Latina NR Select bulkheads combine modern aesthetics with practical functionality.

2
YEAR
WARRANTY

IP65

CLASS
2



- Material construction:
Body & diffuser - polycarbonate
Rim - ABS
- Wattage and CCT selectable
- Suitable for coastal areas

Order No.	Model No.	Description	Wattage (W)	Lumens (lm)	Colour Temp. (K)
LED RESIDENTIAL OUTDOOR BULKHEAD					
2503031241	KSRSF450	Oval Black	8/12/15	825-1570	2700/3000/4000K
2503031242	KSRSF451	Oval White	8/12/15	825-1570	2700/3000/4000K
2503031243	KSRSF452	Oval Black with PIR	8/12/15	825-1570	2700/3000/4000K
2503031244	KSRSF453	Oval White with PIR	8/12/15	825-1570	2700/3000/4000K
2503031245	KSRSF454	Round Black	12/18/20	1125-2150	2700/3000/4000K
2503031246	KSRSF455	Round White	12/18/20	1125-2150	2700/3000/4000K
2503031248	KSRSF456	Round Black with PIR	12/18/20	1125-2150	2700/3000/4000K
2503031249	KSRSF457	Round White with PIR	12/18/20	1125-2150	2700/3000/4000K

Order No.	Model No.	Description
ACCESSORIES		
2503031250	KSRSF458	Black Eyelid Trim

Mains Voltage LED Ground Lights



GL038 Modular is now available in main and low voltage, making it easy for retrofitting and other installs. With a single-point source lens, that provides a modern look and feel. Plus, with an IP65 rating, coastal protection, and IK08 impact protection, this fitting is adequate for a multitude of installs. Available in an array of colours from stainless steel, bronze, black, and antique brass.



- Material construction
Stainless Steel 316 (top)
Brass body
- Suitable for coastal areas
- Supplied with installation tube
- 98mm diameter (85mm cutout)
- Straight to mains



Order No.	Model No.	Description	Wattage (W)	Colour Temp. (K)
MAINS VOLTAGE LED GROUND LIGHTS				
2503015493	GL038SS30MF	Stainless Steel 40°	2.9	3000K
2503015489	GL038AB30MF	Antique Brass 40°	2.9	3000K

Low Voltage LED Ground Lights



The newly upgraded GL019 modular ground light range includes a variety of options such as round, square, frosted, low glare, half moon, and ultra low glare to accommodate any installation or project. This LED-powered ground light is both discreet and powerful, making it ideal for decking areas, entrance halls, and pathways. Indoors or outdoors, the IP68 Stainless Steel finish ground light will provide flawless performance for many years of maintenance-free operation.



- Material Construction: Stainless Steel 316
- Supplied with installation tube
- Suitable for coastal areas
- 40mm Diameter (33mm Cutout)
- 2700K and 4000K and 12° beam angle available on request



Order No.	Model No.	Description	Wattage (W)	Lumens (lm)	Colour Temp. (K)
40MM LOW VOLTAGE LED GROUND LIGHTS					
2503015827	GL019RSS30F	Stainless Steel Flood 40°	0.4 - 2.2		3000K
2503015818	GL019RBK30F	Black Flood 40°	0.4 - 2.2		3000K
2503015809	GL019RAB30F	Antique Brass Flood 40°	0.4 - 2.2		3000K
60MM LOW VOLTAGE LED GROUND LIGHTS					
2503015771	GL016RSS30F	Stainless Steel Flood 40°	1.3 - 2.1	54-210	3000K
2503015716	GL016RBK30S	Black Spot 12°	1.3 - 2.1	54-210	3000K
2503015616	GL016RAB30F	Antique Brass Flood 40°	1.3 - 2.1	54-210	3000K
DRIVER TO SUIT 40 & 60MM DOWNLIGHTS					
2503015186	DRV150700	IP20 Driver to Suit GL016 Ground Lights			

Mains Voltage LED Spike Lights

SL220 is a mains voltage spike light to suit an array of installations. Perfect for creating accent effects such as highlighting a tree trunk as a vertical linear feature. This spike light comes with a robust outdoor cable, coastal protection, and an IP65 rating. The head tilts through 90° from vertical to horizontal for ultimate versatility.



- Material Construction: Stainless Steel 316
- Suitable for coastal areas
- 90 degree head tilt

Order No.	Model No.	Description	Wattage (W)	Lumens (lm)	Colour Temp. (K)
MAINS VOLTAGE LED SPIKE LIGHTS					
2503015615	SL220BK27MF	Black 40°	5.7	515	2700K
2503015620	SL220BK30MF	Black 40°	5.7	520	3000K
2503015651	SL220SS27MF	Stainless Steel 316 40°	5.7	515	2700K
2503015655	SL220SS30MF	Stainless Steel 316 40°	5.7	520	3000K

Low Voltage LED Spike Lights

The SL030 & SL130 are Collingwood's smallest, most stylish and most discreet spike lights for installing by pathways or among the flower beds of your garden. The casing and spike are made from anodised aluminium making them ideal for long periods outside. Using a high-power LED and available in three colour temperatures; 2700K, 3000K and 4000K, this subtle spike light will enhance any environment.



- Material Construction:
Black & Bronze: Anodised aluminium
Stainless Steel: Stainless Steel 316
- Long Spike included for extra stability
- Suitable for use in coastal areas
- Requires separate driver

Order No.	Model No.	Description	Wattage (W)	Lumens (lm)	Colour Temp. (K)
LOW VOLTAGE LED SPIKE LIGHTS					
2500935483	SL13030	Black 26°	1.0/2.0	75/135	3000K
2501188875	SL130ZMBX30	Bronze 26°	1.0/2.0	75/135	3000K
2500260952	SL030 F WW	Stainless Steel 316 26°	1.0/2.0	75/135	3000K
2503015186	DRV150700	IP20 Driver to Suit SL030 & SL130 Spike Lights			

Universal Outdoor LED Spotlight



UL010 Modular is a versatile, swivel-mounted universal light that offers endless possibilities and ensures that any corner of a landscape can be lit, whether that's a pond, tree, or anything in-between. With a 360° stainless-steel bracket, 12° or 40° beam angle, IP68 water-resistance rating, and coastal protection, this feature light is a perfect addition. Available in new colours featuring stainless steel, bronze, black, and antique brass.

- Material Construction:
Body - Stainless Steel 316
- Also available in 2700K and 4000K
- 360° rotation and tilt
- Prewired with 3m H05RN-F cable
- 65mm x 65mm base plate
- Supplied complete with wall fittings
- Suitable for coastal areas



Order No.	Model No.	Description	Wattage (W)	Lumens (lm)	Colour Temp. (K)
UNIVERSAL OUTDOOR LED SPOTLIGHT					
2503015713	UL010SS30XF	Stainless Steel	0.4 - 2.2	54-210	3000K
2503015709	UL010BK30XF	Black	0.4 - 2.2	54-210	3000K
2503015704	UL010AB30XF	Antique Brass	0.4 - 2.2	54-210	3000K
2503015186	DRV150700	IP20 Driver to Suit UL010 Universal Spotlight			

LED Decking Kit



A range of stylish decking kits to add a decorative touch to the garden while also increasing comfort lighting at night.



- Materials Construction:
Body - Plastic
Rim - Stainless Steel grade 304 rim
- Kit includes 10x heads and driver
- Kits are not suitable for composite decking





Order No.	Model No.	Description	Wattage (W)	Lumens (lm)	Colour Temp. (K)
LED DECKING KIT					
2501182937	KSR1333W/W	Decking Kit 3K	0.5	24 per Head	3000K
2501182938	KSR1333C/W	Decking Kit 6K	0.5	24 per Head	6000K

Colour Changing LED Floodlight



The Siena RGB & CCT LED floodlights offer versatile lighting solutions. With the ability to control and synchronize them via the KSR5338 remote control (sold separately), users can easily adjust the colour temperature (CCT) or choose from a spectrum of RGB colours to create the perfect ambiance for any occasion. Whether it's illuminating a garden, highlighting architectural features, or setting the mood for a party, these floodlights provide reliable performance and customisable lighting options. With their durable construction and energy-efficient LED technology, the Siena RGB floodlights are a practical and stylish choice for any lighting project.



-  Aluminium body construction
-  Supplied with 1m cable
-  Floodlights can be synchronised together and dimmed using the remote control

Order No.	Model No.	Description	Wattage (W)	Colour Temp. (K)
COLOUR CHANGING LED FLOODLIGHT				
2503006613	KSR5335	10W RGB Floodlight	10	Tuneable 2700-6500K
2503006614	KSR5336	30W RGB Floodlight	30	Tuneable 2700-6500K
2503006615	KSR5337	50W RGB Floodlight	50	Tuneable 2700-6500K
2503006617	KSR5338	Remote Control for RGB Floodlight		

Garden Spike Kit



2
YEAR
WARRANTY

IP65

Spike Light & Cable

IP20

Adaptor

A family of decorative garden spike lights offering different features to best suit the needs of the installation. The die-cast aluminium housing with a stylish black finish not only looks great but is hardy and robust too. The Garden Spike Lights are a straightforward way to introduce accent garden lighting, thanks to the pre-wired 1M cable and the strong spike making it easy to place into the ground.



 Spike light kit complete with 12V adaptor with UK plug

 Can have up to 8 spike lights per adaptor

Order No.	Model No.	Description
GARDEN SPIKE KIT		
2503027214	LEXGSPK4P40-01	Spike Light Kit (Comes with 4 Spotlights & 12V Adaptor)
2503027215	LEXGSPK2M-01	2m Extension Cable
2503027216	LEXGSPKIP40-01	Extension Spike Light

Outdoor Lighting Festoon



1
YEAR
WARRANTY
25,000 Hours

IP44

IK05

Transform your outdoor space into a warm, welcoming oasis with this connectable and expandable festoon kit from Luceco. This decorative starter kit features 10 bulbs emitting a soft, warm white glow, perfect for creating a cosy ambience. The weatherproof IP44-rated design ensures durability against most elements, while the 12V low voltage system offers safety and efficiency. Easy to install with no complex wiring, it's an ideal lighting solution for gardens, patios, and any outdoor gathering spaces.



Linkable festoon kit, maximum up to 30m

Supplied complete with warm white lamps*

Order No.	Model No.	Description	Length (Metres)	Colour Temp. (K)
OUTDOOR LIGHTING FESTOON				
2503019989	LEXFS10B27UK-01	10m Lighting Festoon with Lamps	10	2700K
2503019991	LEXFS5B27-01	5m Lighting Festoon Extension with Lamps	5	2700K

*Lamps not available separately





Decorative Bollard

Anthracite grey cylindrical bollard with very attractive double horizontal light glow. Designed to complement the FOCUS range of up/down wall lights.

LUTECH

5 YEAR WARRANTY IP44



-  Material construction:
Body - Heavy-duty aluminium
Diffuser - Clear polycarbonate
-  400mm height
-  GU10 Lamp not included,
see pages 178-179 for suitable lamps
-  Matching wall lights available,
see page 141

Order No.	Model No.	Description
DECORATIVE BOLLARD		
2501634440	7204803118	Anthracite Decorative Bollard





Residential Bollard

An attractive heavy duty die cast aluminium bollard, ideal for walkways and security lighting.

KSR LIGHTING

2 YEAR WARRANTY IP65 IK10



-  Material construction:
Body - Die cast aluminium
Diffuser - Polycarbonate
-  CCT switchable
-  140mm diameter
-  Comes complete with concrete mounting kit

Order No.	Model No.	Description	Wattage (W)	Lumens (lm)	Colour Temp. (K)
RESIDENTIAL BOLLARD					
2501245473	KSR9916	450mm Bollard	20	1528/1724/1535	3000/4000/6000K
2501245474	KSR9917	750mm Bollard	20	1528/1724/1535	3000/4000/6000K
2501245475	KSR9918	1000mm Bollard	20	1528/1724/1535	3000/4000/6000K



Order No.	Model No.	Description
ACCESSORIES		
2500678908	KSR9914	Root Mounting Kit

LED Solar Floodlight



Residential solar floodlight perfect for outdoor areas with no mains power available.



-  No wiring, easy & simple installation
-  Automatically turns on to standby glow mode when it gets dark (30lux) and boosts to full power when occupancy detected
-  Lifetime hours are not applicable as the light output is based on the amount of sunlight received

Order No.	Model No.	Description	Wattage (W)	Lumens (lm)	Colour Temp. (K)
LED SOLAR FLOODLIGHT					
2501543318	LEXSF8B40-01	High Output Solar Floodlight	8	800	4000K
2501543317	LEXSF15B40-01	High Output Solar Floodlight	11	1500	4000K

Discover our Industrial Solutions

Contact the specialist team today at Industrial.enquiries@rexel.co.uk

Call **0330 045 0606**

Or scan the QR code for more information

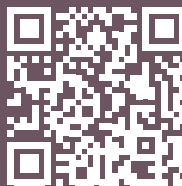

Solar Lighting



IP54



LEXSW30W40-01



LEXSW30B40-01



LEXSL22B30



LEXSBR100B30-01



LEXSWW100B30-01



LEXSFD10BCC-01

The Luceco **Prism Solar Wall Light** delivers 300lm of bright, energy-efficient lighting for outdoor spaces. With a PIR motion sensor and USB-C charging port for backup charge when there's no sun, it offers two lighting modes and ambient backlighting.

The Luceco **Filament Solar Wall Lantern** adds a classic decorative aesthetic while providing 220lm of warm white light. Featuring a PIR motion sensor and 4 lighting modes, it offers reliable, energy-saving lighting, enhancing outdoor spaces and adding security without wiring costs.

The Luceco **Mensa Solar Floodlight** delivers 1500lm brightness with colour options (3000K/4000K). It features a PIR sensor and remote control for easy customization. IP65-rated for all weather, ideal for gardens and driveways.

The Luceco **Era Solar Brick Light** is a decorative, sleek and weatherproof (IP54) solution for outdoor lighting, offering 5 lighting modes and a 1000lm warm white output paired with PIR motion detection. Easy to install, IP54-rated, and powered by solar energy, it's perfect for pathways and gardens.

The Luceco **Stealth Solar Wall Wash Light** offers reliable outdoor lighting with minimum maintenance and hassle-free installation. Its 1000lm output and PIR motion sensor provide security and convenience, while the 5 lighting modes ensure flexible and customisable illumination for any outdoor space.

Order No.	Model No.	Description	Wattage (w)	Lumens (lm)	Colour Temp. (k)
SOLAR LIGHTING					
2503027195	LEXSW30W40-01	White	3	300	4000K
2503027196	LEXSW30B40-01	Black	3	300	4000K
2503027194	LEXSL22B30-01	Decorative Solar Lantern with PIR	2.7	220	3000K
2503027199	LEXSFD10BCC-01	Security Floodlight with PIR	10	1500	3000/4000K
2503027193	LEXSBR100B30-01	Decorative Brick Light with PIR	7	1000	3000K
2503027192	LEXSWW100B30-01	Wall Washer with PIR	7	1000	3000K

14 | LED Strip

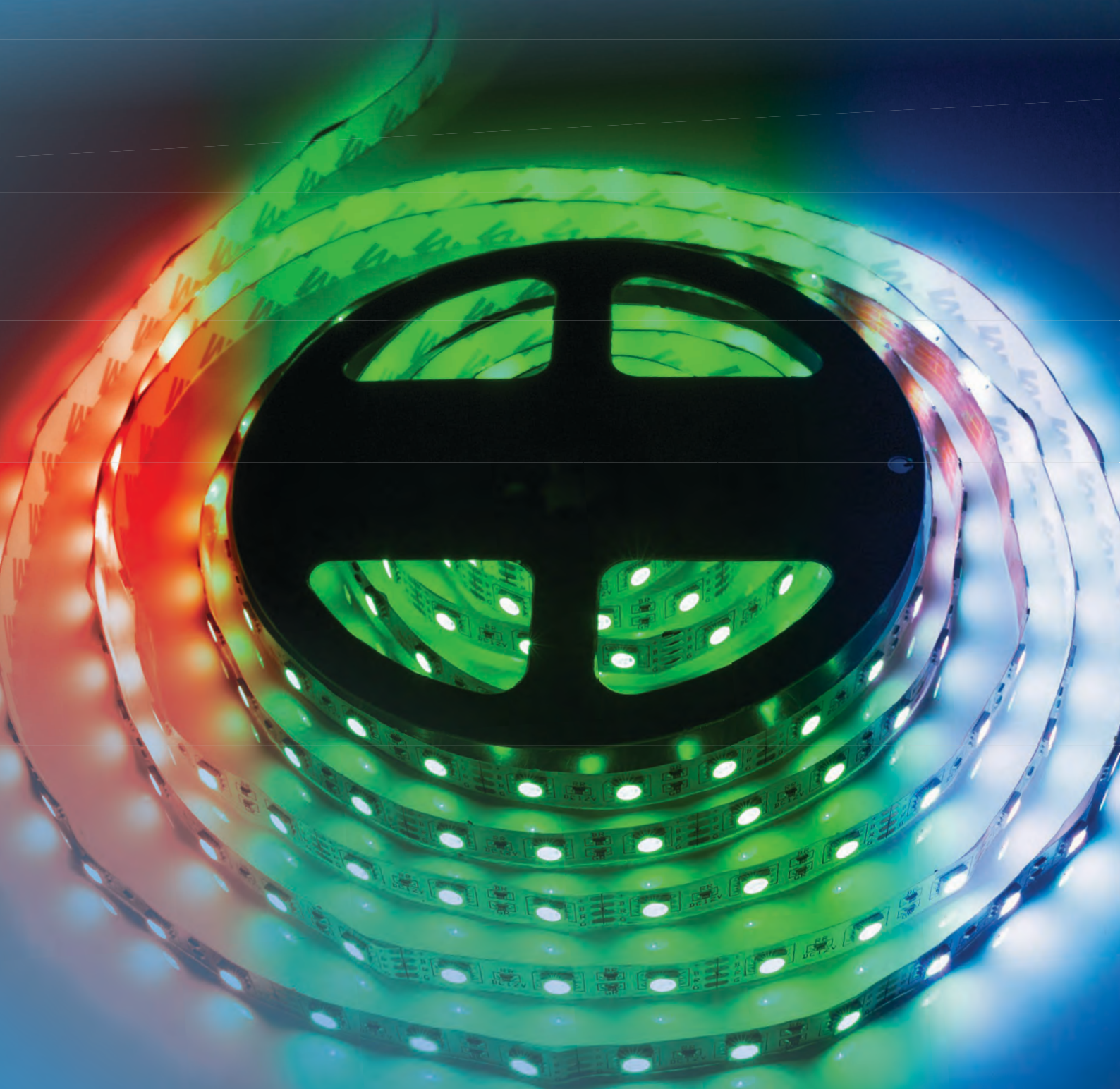

Scan here to see our
full range online



12V LED Flexi Strip Single Colour



This range of LED flexi-strip consists of single colour warm or cool white strip which can be ordered by the metre. Provides a superb lighting effect for domestic, retail, commercial or entertainment venues.

- Cut to length in branch (to nearest metre)
- 8mm width
- Cut points every 50mm
- Wi-Fi control available
- 3m Tape
- 10m maximum run length from each driver



Order No.	Model No.	Description	Length	Wattage per m	LEDs per m	IP Rating	Colour Temp. (K)
LED FLEXI-STRIP IP20							
2501377856	RVA48302050	12V LED Strip Warm White	1m	4.8W	60	IP20	3000K
2501310731	RVA48402050	12V LED Strip Cool White	1m	4.8W	60	IP20	4000K
Order No.	Model No.	Description	Wattage (w)				
DRIVERS							
2503000293	RVA1512N-PSU	12V Constant Voltage IP20 Non-Dimmable LED Driver	15				
2503000295	RVA3012N-PSU	12V Constant Voltage IP20 Non-Dimmable LED Driver	30				
2503000297	RVA6012N-PSU	12V Constant Voltage IP20 Non-Dimmable LED Driver	60				
2503000290	RVA10012N-PSU	12V Constant Voltage IP20 Non-Dimmable LED Driver	100				
2503000251	RVA18012N-PSU	12V Constant Voltage IP20 Non-Dimmable LED Driver	180				
CONNECTORS & ACCESSORIES							
2501511177	RVACCTI-C	Easy Clip IP20 Strip-to-Strip Connector					
2501511178	RVACCTI-C1	Easy Clip IP20 Strip-to-Driver Connector 150mm Lead					
2501536161	RVACCTI-C12	Easy Clip IP20 Strip-to-Driver Connector 2m Lead					
2501511179	RVACCTI-C2	Easy Clip IP20 Strip-to-Strip Connector 150mm Lead					
2501511180	RVACCTI-L	Easy Clip IP20 L-Connector (Pack of 3)					
2501564696	RVACCTI-T	Easy Clip IP20 T-Connector (Pack of 3)					
2501564697	RVACCTI-X	Easy Clip X-Connector (Pack of 3)					
2501564695	RVACCTI-CTRL	Dimming Controller with Hand Held Remote					
2501158929	RVACCTI-WP	Dimmable Controller with Wall Mounted Touch Panel					
2501310747	RVACCTI-WIFI	Wifi Controller 240W Single Colour					



IP67

Cloud Connection

Alexa & Google Home Robus Connect is compatible with Amazon Alexa and Google Assistant. Just search for Smart Life in your Alexa or Google Home companion App.

This allows you to:

- Group other cloud-based devices
- Voice control

How to order

Which LED Flexi-strip do you need?

Waterproof (IP67) or Non Waterproof (IP20)
12V Warm white or neutral white

How long do you need the LED Flexi strip and how many cuts?

How do you want to control the LED Flexi-strip?

Standard installation / Smart WIFI App

Which LED Driver?

12V / 15W / 30W / 60W / 100W

Do you need connectors?

Order No.	Model No.	Description	Length	Wattage per m	LEDs per m	IP Rating	Colour Temp. (K)
LED FLEXI-STRIP IP67							
2501310730	RVA48306730	12V LED Strip Warm White	1m	4.8W	60	IP67	3000K
2501310732	RVA48406730	12V LED Strip Cool White	1m	4.8W	60	IP67	4000K

Order No.	Model No.	Description	Wattage (W)
DRIVERS			
2503000258	RVA601267N-PSU	12V Constant Voltage IP67 Non-Dimmable LED Driver	60
2503000252	RVA1001267N-PSU	12V Constant Voltage IP67 Non-Dimmable LED Driver	100
2503000254	RVA2001267N-PSU	12V Constant Voltage IP67 Non-Dimmable LED Driver	200

CONNECTORS & ACCESSORIES

2501310741	RVAN67-C	Easy Clip IP67 Strip-to-Strip Connector
2501508004	RVA67N-C1	Easy Clip IP67 Strip-to-Driver Connector 150mm Lead
2501508005	RVA67N-C12	Easy Clip IP67 Strip-to-Driver Connector 2m Lead
2501310743	RVA67N-C2	Easy Clip IP67 Strip-to-Strip Connector 150mm Lead
2501310744	RVA67-EC	5 End Caps & 10 Clips for IP67 Strip
2501310745	RVA67-G	Glue for IP67 LED Strip Connectors
2501310746	RVA67-H	Heat Shrink for IP67 LED Strip Connectors

24V LED Flexi Strip RGBW



IP20

This range of LED flexi-strip consists of RGBW colour changing strip which can be ordered by the metre. Provides a superb lighting effect for domestic, retail, commercial or entertainment venues.

- Cut to length in branch (to nearest metre)
- 12mm Width
- Cut points every 100mm
- Wi-Fi control available
- 3m Tape
- 10m maximum run length from each driver



Order No.	Model No.	Description	Length	Wattage per m	LEDs per m	IP Rating	Colour Temp. (K)
LED FLEXI-STRIP IP20							
2501168742	RVA12RGBW2030-30	24V LED Strip RGB & Warm White	1m	12W	60	IP20	3000K
2501168743	RVA12RGBW2030-40	24V LED Strip RGB & Cool White	1m	12W	60	IP20	4000K

Order No.	Model No.	Description	Wattage (w)
DRIVERS			
2503000294	RVA1524N-PSU	24V Constant Voltage IP20 Non-Dimmable LED Driver	15
2503000296	RVA3024N-PSU	24V Constant Voltage IP20 Non-Dimmable LED Driver	30
2503000298	RVA6024N-PSU	24V Constant Voltage IP20 Non-Dimmable LED Driver	60
2503000291	RVA10024N-PSU	24V Constant Voltage IP20 Non-Dimmable LED Driver	100
2503000292	RVA15024N-PSU	24V Constant Voltage IP20 Non-Dimmable LED Driver	150
2503000256	RVA24024N-PSU	24V Constant Voltage IP20 Non-Dimmable LED Driver	240
2503000257	RVA32024N-PSU	24V Constant Voltage IP20 Non-Dimmable LED Driver	320

CONNECTORS & ACCESSORIES		
2501278142	RVARGWBN-C	Easy Clip IP20 Strip-to-Strip Connector for RGB Strip
2501278143	RVARGWBN-C1	Easy Clip IP20 Strip-to-Driver Connector for RGB Strip with 150mm Lead
2501278144	RVARGWBN-C2	Easy Clip IP20 Strip-to-Strip Connector for RGB Strip with 150mm Lead
2501176368	RVARGWBL-CONN	Easy Clip L-Connector for RGB Strip (Pack of 3)
2501176369	RVARGWBT-CONN	Easy Clip T-Connector for RGB Strip (Pack of 3)
2501176371	RVARGWBX-CONN	Easy Clip X-Connector for RGB Strip (Pack of 3)
2501278134	RVA67RGBW-EC	Easy Clip Accessories for 24V RGBW IP67 LED Strip /5 End Caps, 10 Clips
2501176367	RVARGBW-CTRL	Dimming Controller with Hand Held Remote for RGB Strip
2501176370	RVARGBW-WP	Dimmable Controller with Wall Mounted Touch Panel for RGB Strip
2501183214	RVARGBW-WIFI	Wifi Controller 240W RGBW

IP67

Cloud Connection

Alexa & Google Home Robus Connect is compatible with Amazon Alexa and Google Assistant. Just search for Smart Life in your Alexa or Google Home companion App.

This allows you to:

- Group other cloud-based devices
- Voice control

How to order

Which LED Flexi-strip do you need?

Waterproof (IP67) or Non Waterproof (IP20)
12V Warm white or neutral white

How long do you need the LED Flexi strip and how many cuts?

How do you want to control the LED Flexi-strip?

Standard installation / Smart WIFI App

Which LED Driver?

12V / 15W / 30W / 60W / 100W

Do you need connectors?

Order No.	Model No.	Description	Length	Wattage per m	LEDs per m	IP Rating	Colour Temp. (K)
-----------	-----------	-------------	--------	---------------	------------	-----------	------------------

LED FLEXI-STRIP IP67

2501465846	RVA12RGBW6730-30	24V LED Strip RGB & Warm White	1m	12W	60	IP67	3000K
2501490916	RVA12RGBW6730-40	24V LED Strip RGB & Cool White	1m	12W	60	IP67	4000K

Order No.	Model No.	Description	Wattage (W)
-----------	-----------	-------------	-------------

DRIVERS

2503000259	RVA602467N-PSU	24V Constant Voltage IP67 Non-Dimmable LED Driver	60
2503000253	RVA1002467N-PSU	24V Constant Voltage IP67 Non-Dimmable LED Driver	100
2503000255	RVA2002467N-PSU	24V Constant Voltage IP67 Non-Dimmable LED Driver	200

CONNECTORS & ACCESSORIES

2501278142	RVARGBWN-C	Easy Clip IP20 Strip-to-Strip Connector for RGB Strip
2501278143	RVARGBWN-C1	Easy Clip IP20 Strip-to-Driver Connector for RGB Strip with 150mm Lead
2501278144	RVARGBWN-C2	Easy Clip IP20 Strip-to-Strip Connector for RGB Strip with 150mm Lead
2501176368	RVARGBWL-CONN	Easy Clip L-Connector for RGB Strip (Pack of 3)
2501176369	RVARGBWT-CONN	Easy Clip T-Connector for RGB Strip (Pack of 3)
2501176371	RVARGBW-X-CONN	Easy Clip X-Connector for RGB Strip (Pack of 3)
2501278134	RVA67RGBW-EC	Easy Clip Accessories for 24V RGBW IP67 LED Strip /5 End Caps, 10 Clips
2501176367	RVARGBW-CTRL	Dimming Controller with Hand Held Remote for RGB Strip
2501176370	RVARGBW-WP	Dimmable Controller with Wall Mounted Touch Panel for RGB Strip
2501183214	RVARGBW-WIFI	Wifi Controller 240W RGBW

24V LED Spotless COB Strip



IP20

IP67

Dotless light effect without need of use of additional diffusers and available in IP20 or IP67 versions to suit any indoor or outdoor application. The entire range comprises single CCT versions available in 3000K and 4000K and RGB plus white with same colour temperature options available in pre-cut 1m, 3m or 5m lengths.



Order No.	Model No.	Description	Length	Wattage per m	LEDs per m	IP Rating	Colour Temp. (K)
LED COB STRIP SINGLE COLOUR							
2501634728	RVC3K1	7W/m 24V LED Striplight 3000K IP20	1m	7W	IP20	3000K	3000K
2501634729	RVC3K3	7W/m 24V LED Striplight 3000K IP20	3m	7W	IP20	3000K	3000K
2501634731	RVC3K5	7W/m 24V LED Striplight 3000K IP20	5m	7W	IP20	3000K	3000K
2501634735	RVC4K1	7W/m 24V LED Striplight 4000K IP20	1m	7W	IP20	4000K	3000K
2501634736	RVC4K3	7W/m 24V LED Striplight 4000K IP20	3m	7W	IP20	4000K	3000K
2501634737	RVC4K5	7W/m 24V LED Striplight 4000K IP20	5m	7W	IP20	4000K	3000K
2501634732	RVC3K671	7W/m 24V LED Striplight 3000K IP67	1m	7W	IP67	3000K	3000K
2501634733	RVC3K673	7W/m 24V LED Striplight 3000K IP67	3m	7W	IP67	3000K	3000K
2501634734	RVC3K675	7W/m 24V LED Striplight 3000K IP67	5m	7W	IP67	3000K	3000K
2501634738	RVC4K671	7W/m 24V LED Striplight 4000K IP67	1m	7W	IP67	4000K	3000K
2501634739	RVC4K673	7W/m 24V LED Striplight 4000K IP67	3m	7W	IP67	4000K	3000K
2501634740	RVC4K675	7W/m 24V LED Striplight 4000K IP67	5m	7W	IP67	4000K	4000K

Order No.	Model No.	Description	Wattage (W)
DRIVERS			
2503000294	RVA1524N-PSU	IP20 Constant Voltage Non-Dimmable Driver	15
2503000296	RVA3024N-PSU	IP20 Constant Voltage Non-Dimmable Driver	30
2503000298	RVA6024N-PSU	IP20 Constant Voltage Non-Dimmable Driver	60
2503000291	RVA10024N-PSU	IP20 Constant Voltage Non-Dimmable Driver	100

CONNECTORS			
2501378286	RMU-C	IP20 Single Colour Strip to Strip Clip Connector	
2501378287	RMU-C1	IP20 Single Colour Strip to Driver Connector 150mm Wires	
2501378288	RMU-C2	IP20 Single Colour Strip to Strip Connector 150mm Wires	
2501378283	RMU67-C	IP67 Single Colour Strip to Strip Clip Connector	
2501378284	RMU67-C1	IP67 Single Colour Strip to Driver Connector 150mm Wires	
2501378285	RMU67-C2	IP67 Single Colour Strip to Strip Connector 150mm Wires	



IP20

IP67



Pre-cut to length and pre-wired with 1m tails



Suitable for 24V LED drivers



High quality 3m self-adhesive back tape



Cut points every 45mm



IP20 version - 10mm width
IP67 version - 12.5mm width



Up to 860 lumens per metre



10m maximum run length from each driver

Order No.	Model No.	Description	Length	Wattage per m	LEDs per m	IP Rating	Colour Temp. (K)
LED COB STRIP RGBW							
2501634742	RVCRGBW3K1	RGBW 14W/m 24V LED Striplight 3000K IP20	1m	14W	IP20	3000K	3000K
2501634743	RVCRGBW3K3	RGBW 14W/m 24V LED Striplight 3000K IP20	3m	14W	IP20	3000K	3000K
2501634744	RVCRGBW3K5	RGBW 14W/m 24V LED Striplight 3000K IP20	5m	14W	IP20	3000K	3000K
2501634748	RVCRGBW4K1	RGBW 14W/m 24V LED Striplight 4000K IP20	1m	14W	IP20	4000K	3000K
2501634749	RVCRGBW4K3	RGBW 14W/m 24V LED Striplight 4000K IP20	3m	14W	IP20	4000K	3000K
2501634750	RVCRGBW4K5	RGBW 14W/m 24V LED Striplight 4000K IP20	5m	14W	IP20	4000K	3000K
2501634745	RVCRGBW3K671	RGBW 14W/m 24V LED Striplight 3000K IP67	1m	14W	IP67	3000K	3000K
2501634746	RVCRGBW3K673	RGBW 14W/m 24V LED Striplight 3000K IP67	3m	14W	IP67	3000K	3000K
2501634747	RVCRGBW3K675	RGBW 14W/m 24V LED Striplight 3000K IP67	5m	14W	IP67	3000K	3000K
2501634751	RVCRGBW4K671	RGBW 14W/m 24V LED Striplight 4000K IP67	1m	14W	IP67	4000K	3000K
2501634753	RVCRGBW4K673	RGBW 14W/m 24V LED Striplight 4000K IP67	3m	14W	IP67	4000K	3000K
2501634754	RVCRGBW4K675	RGBW 14W/m 24V LED Striplight 4000K IP67	5m	14W	IP67	4000K	4000K

Order No.	Model No.	Description	Wattage (W)
DRIVERS			
2503000294	RVA1524N-PSU	IP20 Constant Voltage Non-Dimmable Driver	15
2503000296	RVA3024N-PSU	IP20 Constant Voltage Non-Dimmable Driver	30
2503000298	RVA6024N-PSU	IP20 Constant Voltage Non-Dimmable Driver	60
2503000291	RVA10024N-PSU	IP20 Constant Voltage Non-Dimmable Driver	100



CONNECTORS			
2501667469	RVCRGBW-C	IP20 RGBW Strip to Strip Connector	
2501667459	RVCRGBW-C1	IP20 RGBW Strip to Driver Connector 150mm Wires	
2501667460	RVCRGBW-C2	IP20 RGBW Strip to Strip Connector 150mm Wires	
2501667458	RVC67RGBW-C	IP67 RGBW Strip to Strip Connector	
2501667462	RVC67RGBW-C1	IP67 RGBW Strip to Driver Connector 150mm Wires	
2501667464	RVC67RGBW-C2	IP67 RGBW Strip to Strip Connector 150mm Wires	
2501564666	RMU67-EC	End Caps and Mounting Clips	

LED Strip Extrusion

ROBUS®

A range of aluminium extrusion for use with Robus LED strip.

3
YEAR
WARRANTY

-  Supplied in 2m lengths
-  Comes with mounting clips, end caps and diffuser
-  Anodised aluminium



Order No.	Model No.	Description
LED STRIP EXTRUSION		
2501536154	REXS092-23	Surface Mounted LED Profile for Single Colour & RGBW LED Tape
2501536152	REXR212-23	Recessed Mounted LED Profile for Single Colour & RGBW LED Tape
2501176398	REXS122-23	Surface Mounted LED Profile for Single Colour & RGBW LED Tape
2501348479	REXA172-23	45 Degree Angle LED Profile for Single Colour LED Tape

24V LED Free Cut Strip



- Cut ANYWHERE for millimetre perfect precision
- 2400K colour temperature available on request
- Dimmable when used with suitable drivers
- 10m, 30m and 50m reels available on request
- CRI92+

Order No.	Model No.	Description	Length	Wattage per m	LEDs per m	IP Rating	Colour Temp. (K)
LED FREE CUT STRIP							
2501632927	FLSFC1-0GICB11	8mm Width 5m Reel	5m	5W	480	IP20	2700K
2501632905	FLSFC1-0CICB11	8mm Width 5m Reel	5m	5W	480	IP20	3000K
2501632971	FLSFC1-0NICB11	8mm Width 5m Reel	5m	5W	480	IP20	4000K
2501632915	FLSFC3-0GICB31	8mm Width 5m Reel	5m	10W	480	IP20	2700K
2501632913	FLSFC3-0CICB31	8mm Width 5m Reel	5m	10W	480	IP20	3000K
2501632920	FLSFC3-0NICB31	8mm Width 5m Reel	5m	10W	480	IP20	4000K
2501632924	FLSFC3-5GICB31	10mm Width 5m Reel	5m	10W	480	IP65	2700K
2501632922	FLSFC3-5CICB31	10mm Width 5m Reel	5m	10W	480	IP65	3000K
2501632929	FLSFC3-5NICB31	10mm Width 5m Reel	5m	10W	480	IP65	4000K

Order No.	Model No.	Description	Wattage (w)
DRIVERS			
2501516343	LEDD-IP3024	24V Constant Voltage IP65 Non-Dimmable LED Driver	30
2501525693	LEDD-IP6024	24V Constant Voltage IP67 Non-Dimmable LED Driver	60
2501525683	LEDD-IP10024	24V Constant Voltage IP67 Non-Dimmable LED Driver	100
2501525684	LEDD-IP15024	24V Constant Voltage IP67 Non-Dimmable LED Driver	150
2501516362	DIMD-2524	TRIAC / Mains Dimmable 24V LED Driver IP20	25
2501516364	DIMD-5024	TRIAC / Mains Dimmable 24V LED Driver IP20	50
2501516366	DIMD-IP10024	TRIAC / Mains Dimmable 24V LED Driver IP66	100
2501516367	DIMD-IP15024	TRIAC / Mains Dimmable 24V LED Driver IP66	150

Order No.	Model No.	Description
CONNECTORS		
2501516411	FLSW8SML	Strip-to-Wire Connector for IP20 8mm Width Strip 1000mm Lead
2501516412	FLSW8SML-5M	Strip-to-Wire Connector for IP20 8mm Width Strip 5m Lead
2501516466	FLSS8SML	Strip-to-Strip Connector for IP20 8mm Width Strip
2501606735	FLSL8SML	Right Angle Connector for IP20 8mm Width Strip
2501525713	FLSC8SML-5CM	Corner Connector for IP20 8mm Width Strip 50mm Lead
2501516617	FLSC8SML	Corner Connector for IP20 8mm Width Strip 150mm Lead

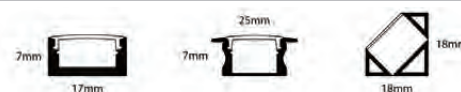

Order No.	Model No.	Description
PROFILES		
2503000904	PRO1-82MO-D	2m Surface Mount Profile with Opal Diffuser, End Caps & Mounting Brackets - 17 x 7mm
2503000905	PRO1-82MO-10	(x10 Pack) 2m Surface Mount Profile with Opal Diffuser, End Caps & Mounting Brackets - 17 x 7mm
2503000906	PROIR-82MO-D	2m Recessed Profile with Opal Diffuser & End Caps - 25 x 7mm
2503000907	PRO7-82MO-D	2m Angled Profile with Opal Diffuser, End Caps & Mounting Brackets - 18 x 18mm



See the full
FREE CUT COB Series



CUT ANYWHERE

Cut anywhere along the LED strip PCB for a millimetre perfect finish; cuts do not have to be made on copper pads.

LED STRIPS

**THE FREE CUT
COB SERIES**

Cut anywhere along the strip for a perfectly tailored fit. High-density COB LEDs create a continuous, dotless line of light for clean, professional lighting installations.



CONNECT ANYWHERE

Reliable crimp connections pierce the PCB anywhere along the LED strip; connections do not need to be made on copper pads.

**The lighting
specialists for
professionals.**

We stock **1000s** of LED Strip variations, **300+** Aluminium Profile models and a complete Neon Flex range including Top, Side and 3D bending variations



See the full
ALUMINIUM PROFILE Series



SURFACE PROFILE
PRO1-8



SURFACE PROFILE
PRO2-8



ANGLED PROFILE
PRO7-8

MOUNTING PROFILES

THE ALUMINIUM PROFILE SERIES

Manufactured from durable 6063 anodised aluminium, the Aluminium Profile Series offers a clean, professional finish while providing protection and effective heat dissipation.



See the full
NEON FLEX Series

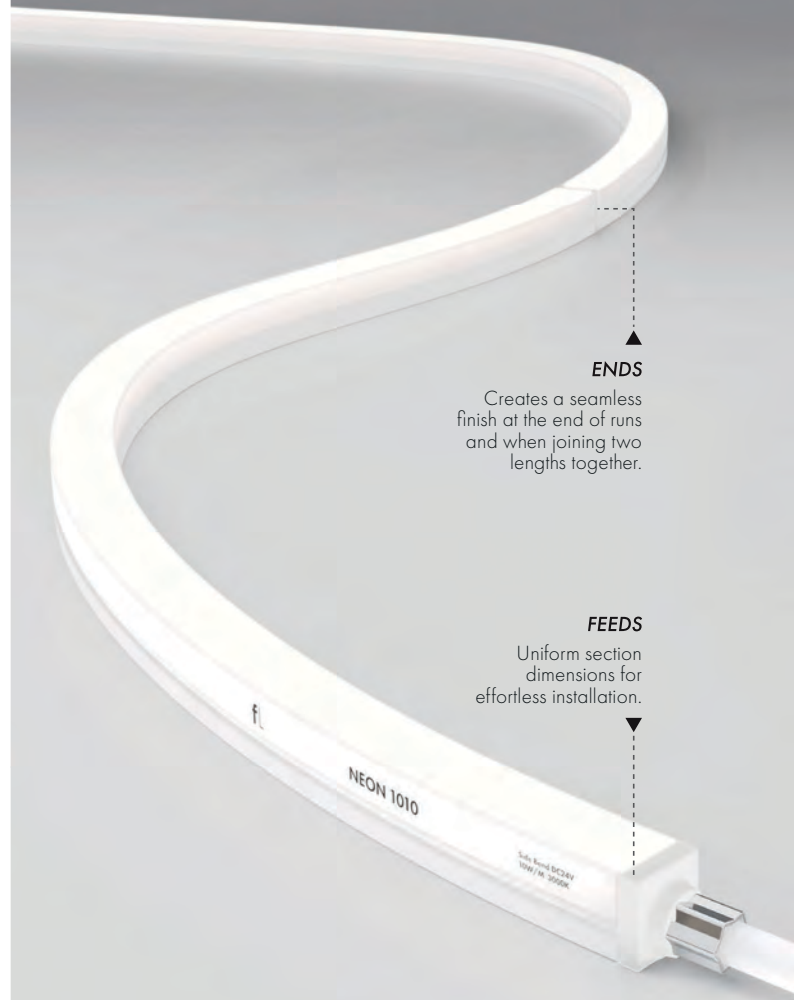

ENDS

Creates a seamless finish at the end of runs and when joining two lengths together.

FEEDS

Uniform section dimensions for effortless installation.

FLEXIBLE & DURABLE LIGHTING

THE NEON FLEX SERIES

The Neon Flex Series delivers a seamless, dot-free line of light with exceptional flexibility and durability. Premium silicone construction is ideal for linear, curved and outdoor lighting.

Complete your installation with
Profiles | Drivers | Wire
Controllers | Decoders

We are proud to customise LED
Strip and Injection Mould NEON
Flex in our **UK Assembly Plant**



**Download
the app
today!**



 Scan Me

REXEL

Denmans
REXEL GROUP

£5 OFF

**when you spend
£50 (ex VAT)
on your first
order using the
Rexel App**



**Instant access to our
full product range right
at your fingertips**



**Ultra-fast product
searches and seamless
checkout for effortless
shopping**



**Easily convert quotes
online and manage
payments**



15 | Lamps



Scan here to see our
full range online



LED GLS

Introducing the brand new range of Newlec LED lamps which has been specifically manufactured for Rexel and Denmans in the UK. The range has been designed with both quality and affordability in mind. Featuring a 3 year warranty for peace of mind, you can trust in Newlec to get the job done. Bright, efficient and designed to replace traditional incandescent and halogen bulbs, our LED GLS lamp delivers crisp, natural light with up to 85% less energy use and a long life of up to 15,000 hours. Available in a warm white colour temperature and standard Edison Screw and Bayonet Cap fittings, it provides instant full brightness with no flicker and excellent colour rendering for comfortable, true-to-life illumination. Ideal for living rooms, kitchens, hallways and commercial fixtures, this low-heat, mercury-free lamp cuts running costs and maintenance while offering a familiar GLS shape that fits existing fixtures.

3
YEAR
WARRANTY

IP20

NEW



 Multipacks available from September 2026

 806 lumens, equivalent to 60W incandescent lamps

 Dimmable and Non-Dimmable options available

Order No.	Model No.	Description	Base	Wattage (W)	Lumens (lm)	Clear / Frosted	Traditional Equivalent	Colour Temp. (K)
LED GLS								
2503031639	NLGLSBC6027ND-01	Non-Dimmable	BC (B22)	8	806	Frosted	60W	2700K
2503031640	NLGLSES6027ND-01	Non-Dimmable	ES (E27)	8	806	Frosted	60W	2700K
2503039050	NLGLSBC6027ND-01/5PK	5 Pack Non-Dimmable	BC (B22)	8	806	Frosted	60W	2700K
2503039051	NLGLSES6027ND-01/5PK	5 Pack Non-Dimmable	ES (E27)	8	806	Frosted	60W	2700K
2503031641	NLGLSBC6027D-01	Dimmable	BC (B22)	8	806	Frosted	60W	2700K
2503031642	NLGLSES6027D-01	Dimmable	ES (E27)	8	806	Frosted	60W	2700K

NEW CATALOGUE

1000s of products from exclusive brands





View now at: www.rexel.co.uk/uki/E-catalogue



CorePro LED Frosted GLS Non Dimmable

PHILIPS

 Market leading Philips quality LED lamps

 Non dimmable



15,000
HOUR LIFE

2
YEAR
WARRANTY
8,000 Hours

IP20

CRI
90

Order No.	Model No.	Base	Wattage (W)	Lumens (lm)	Clear / Frosted	Traditional Equivalent	Colour Temp. (K)
COREPRO LED FROSTED GLS NON DIMMABLE							
2503049284	929003540208	ES (E27)	5.5	470	Frosted	40W	2700K
2503049285	929003603102	BC (B22)	5.5	470	Frosted	40W	2700K
2503049286	929002306208	ES (E27)	8	806	Frosted	60W	2700K
2450070339	929003543799	BC (B22)	8	806	Frosted	60W	2700K
2503031393	929003544102	ES (E27)	11	1055	Frosted	75W	2700K
2501524736	929003544599	BC (B22)	11	1055	Frosted	75W	2700K
2503049287	929002306808	ES (E27)	13	1521	Frosted	100W	2700K
2450070342	929003003899	BC (B22)	13	1521	Frosted	100W	2700K
2503049288	929003564108	ES (E27)	5	470	Frosted	40W	4000K
2503049289	929002306308	ES (E27)	7.5	806	Frosted	60W	4000K
2503031394	929003544302	ES (E27)	10	1055	Frosted	75W	4000K
2450020471	929003004102	ES (E27)	12.5	1521	Frosted	100W	4000K

Master Value LED Frosted GLS Dimmable

PHILIPS

 Market leading Philips quality LED lamps

 Dimmable



15,000
HOUR LIFE

2.5
YEAR
WARRANTY
10,000 Hours

IP20

CRI
90

Order No.	Model No.	Base	Wattage (W)	Lumens (lm)	Clear / Frosted	Traditional Equivalent	Colour Temp. (K)
MASTER VALUE LED FROSTED GLS DIMMABLE							
2501166322	929003070702	ES (E27)	3.4	470	Frosted	40W	2700K
2450020448	929003010699	BC (B22)	5.9	806	Frosted	60W	2700K
2501166326	929003058102	ES (E27)	7.8	1055	Frosted	75W	2700K
2501423466	929003058502	ES (E27)	11.2	1521	Frosted	100W	2700K
2501166329	929003011899	BC (B22)	10.5	1521	Frosted	100W	2700K

Master GLS Dimtone

PHILIPS

 Market leading Philips quality LED lamps

 DimTone - colour temperature gets warmer as you dim



25,000

HOUR LIFE

5

YEAR
WARRANTY
20,000 Hours

IP20

CRI
90

Order No.	Model No.	Base	Wattage (W)	Lumens (lm)	Clear / Frosted	Traditional Equivalent	Colour Temp. (K)
MASTER GLS DIMTONE							
2503000260	929003798502	ES (E27)	3.4	470	Clear	40W	2700 - 2200K
2503000261	929003799302	BC (B22)	3.4	470	Clear	40W	2700 - 2200K
2503000263	929003799402	BC (B22)	5.9	806	Clear	60W	2700 - 2200K
2503000264	929003798802	ES (E27)	10.5	1521	Clear	100W	2700 - 2200K

GLS Photocell Sensor

Ideal for external porches, walkways, paths and patios.
To be used in suitable enclosed outdoor fittings.

 Automatically switches ON at dusk and OFF at dawn

 Dual daylight sensors give 360° coverage

 Non dimmable



integral LED

2

YEAR
WARRANTY
15,000 Hours

IP20

CRI
80

Order No.	Model No.	Base	Wattage (W)	Lumens (lm)	Traditional Equivalent	Colour Temp. (K)
GLS PHOTOCCELL SENSOR						
2450068744	ILGLSE27SC118	ES (E27)	4.8	470	40W	2700K
2450068743	ILGLSB22SC125	BC (B22)	4.8	470	40W	2700K
2450069404	ILGLSE27SE144	ES (E27)	4.8	470	40W	4000K
2450069402	ILGLSB22SE142	BC (B22)	4.8	470	40W	4000K
2503039091	ILGLSE27SC198	ES (E27)	8	806	60W	2700K
2450015293	ILGLSB22SC042	BC (B22)	8	806	60W	2700K
2450069405	ILGLSE27SE145	ES (E27)	8	806	60W	4000K
2450069403	ILGLSB22SE143	BC (B22)	8	806	60W	4000K

LED Candles



Bright, efficient and designed to replace traditional incandescent and halogen bulbs, our LED candle lamp delivers crisp, natural light with up to 85% less energy use and a long life of up to 15,000 hours. Available in a warm white and cool white temperatures and standard Small Edison Screw and Bayonet Cap fittings, it provides instant full brightness with no flicker and excellent colour rendering for comfortable, true-to-life illumination. Ideal for living rooms, kitchens, hallways and commercial fixtures, this low-heat, mercury-free lamp cuts running costs and maintenance while offering a familiar shape that fits existing fixtures.

 Multipacks available from September 2026

 470 lumens, equivalent to 40W incandescent lamps

 Non-Dimmable



Order No.	Model No.	Description	Base	Wattage (W)	Lumens (lm)	Clear / Frosted	Fluorescent Equivalent	Colour Temp. (K)
LED CANDLES								
2503031646	NLCANSES4027ND-01	Non-Dimmable	SES (E14)	4.9	470	Frosted	40W	2700K
2503031647	NLCANSES4040ND-01	Non-Dimmable	SES (E14)	4.9	470	Frosted	40W	4000K
2503031648	NLCANBC4027ND-01	Non-Dimmable	BC (B22)	4.9	470	Frosted	40W	2700K
2503031649	NLCANBC4040ND-01	Non-Dimmable	BC (B22)	4.9	470	Frosted	40W	4000K
2503039052	NLCANSES4027ND-01/4PK	4 Pack Non-Dimmable	SES (E14)	4.9	470	Frosted	40W	2700K
2503039053	NLCANBC4027ND-01/4PK	4 Pack Non-Dimmable	BC (B22)	4.9	470	Frosted	40W	2700K

CorePro LED Filament Candle Non Dimmable

PHILIPS

15,000
HOUR LIFE2
YEAR
WARRANTY
8,000 Hours

IP20

CRI
80

 Market leading Philips quality LED lamps

 Non dimmable



Order No.	Model No.	Base	Wattage (W)	Lumens (lm)	Clear / Frosted	Traditional Equivalent	Colour Temp. (K)
COREPRO LED FILAMENT CANDLE NON DIMMABLE							
2501016727	929001238392	SES (E14)	2	250	Candle	25W	2700K
2501016728	929001238492	SES (E14)	2	250	Bent-Tip	25W	2700K
2450020499	929001238592	SES (E14)	2	250	Twisted	25W	2700K
2503000266	929001889792	SES (E14)	4.3	470	Candle	40W	2700K
2501421471	929002028092	SES (E14)	6.5	806	Candle	60W	2700K

Master Value LED Filament Candle DimTone

PHILIPS

25,000
HOUR LIFE2.5
YEAR
WARRANTY
10,000 Hours

IP20

CRI
90+

 Market leading Philips quality LED lamps

 DimTone - the colour gets warmer as you dim



Order No.	Model No.	Base	Wattage (W)	Lumens (lm)	Clear Frosted	Traditional Equivalent	Colour Temp. (K)
MASTER VALUE LED FILAMENT CANDLE DIMTONE							
2450070581	929003011982	SES (E14)	2.5	340	Candle	25W	2700K - 2200K
2501524743	929003012242	SES (E14)	3.4	470	Candle	40W	2700K - 2200K
2450070582	929003012382	ES (E27)	3.4	470	Candle	40W	2700K - 2200K
2501524748	929003013082	SES (E14)	3.4	470	Bent-Tip	40W	2700K - 2200K
2450070574	929003013982	SES (E14)	5.9	806	Candle	60W	2700K - 2200K

CorePro LED Golfball Non Dimmable

PHILIPS

15,000
HOUR LIFE

2
YEAR
WARRANTY
8,000 Hours

IP20

**CRI
80**

 Market leading Philips quality LED lamps

 Non dimmable



Order No.	Model No.	Base	Wattage (W)	Lumens (lm)	Clear / Frosted	Traditional Equivalent	Colour Temp. (K)
COREPRO LED GOLFBALL NON DIMMABLE							
2501519575	929001238692	SES (E14)	2	250	Clear	25W	2700K
2501519576	929001238792	ES (E27)	2	250	Clear	25W	2700K
2501519577	929001890492	SES (E14)	4.3	470	Clear	40W	2700K
2501519578	929001890592	ES (E27)	4.3	470	Clear	40W	2700K
2501519579	929002028592	SES (E14)	6.5	806	Clear	60W	2700K
2501519580	929002029092	ES (E27)	6.5	806	Clear	60W	2700K
2450020531	929001345492	SES (E14)	2.2	250	Frosted	25W	2700K
2450020532	929001345692	ES (E27)	2.2	250	Frosted	25W	2700K
2450020533	929001345592	SES (E14)	4.3	470	Frosted	40W	2700K
2450020534	929001345792	ES (E27)	4.3	470	Frosted	40W	2700K
2450020535	929002028792	SES (E14)	6.5	806	Frosted	60W	2700K
2450020536	929002029292	ES (E27)	6.5	806	Frosted	60W	2700K

Ask us about our

MASSIVE Cable Offer

Includes cut lines!



Decorative Filament Lamps



IP20

NEW



Order No.	Model No.	Description	Base	Wattage (W)	Lumens (lm)	Clear / Gold	Colour Temp. (K)
DECORATIVE FILAMENT LAMPS							
2503019982	FST4.2D-BC27	ST64 Dimmable	BC (B22)	4.2	450	Clear	2700K
2503019983	FST4.2D-ES27	ST64 Dimmable	ES (E27)	4.2	450	Clear	2700K
2501632631	VST4.2-BC25	ST64 Non-Dimmable	BC (B22)	4.2	450	Gold	2500K
2501632632	VST4.2-ES25	ST64 Non-Dimmable	ES (E27)	4.2	450	Gold	2500K
2501632629	VST4.2D-BC25	ST64 Dimmable	BC (B22)	4.2	450	Gold	2500K
2450013721	VST4.2D-ES25	ST64 Dimmable	ES (E27)	4.2	450	Gold	2500K
2450013724	FGL4.2D-BC27	125mm Globe Dimmable	BC (B22)	4.2	450	Clear	2700K
2450013725	FGL4.2D-ES27	125mm Globe Dimmable	ES (E27)	4.2	450	Clear	2700K
2503039598	VGL4.2-BC25	125mm Globe Non-Dimmable	BC (B22)	4.2	450	Gold	2500K
2450070263	VGL4.2-ES25	125mm Globe Non-Dimmable	ES (E27)	4.2	450	Gold	2500K
2503039605	VGL4.2D-BC25	125mm Globe Dimmable	BC (B22)	4.2	450	Gold	2500K
2450013717	VGL4.2D-ES25	125mm Globe Dimmable	ES (E27)	4.2	450	Gold	2500K
2503039604	VGM4.2-BC25	95mm Globe Non-Dimmable	BC (B22)	4.2	450	Gold	2500K
2450070261	VGM4.2-ES25	95mm Globe Non-Dimmable	ES (E27)	4.2	450	Gold	2500K
2503039603	VGM4.2D-BC25	95mm Globe Dimmable	BC (B22)	4.2	450	Gold	2500K
2450013715	VGM4.2D-ES25	95mm Globe Dimmable	ES (E27)	4.2	450	Gold	2500K

CorePro LED MR16 Non Dimmable



PHILIPS

15,000
HOUR LIFE

2
YEAR
WARRANTY
8,000 Hours

IP20

CRI
80

-  Market leading Philips quality LED lamps
-  36° Beam
-  Non dimmable



Order No.	Model No.	Base	Wattage (W)	Lumens (lm)	Traditional Equivalent	Colour Temp. (K)
COREPRO LED MR16 NON DIMMABLE						
2503049292	929002494602	MR16	4.4	345	35W	2700K
2503049293	929002494702	MR16	4.4	390	35W	4000K
2500050221	HTM70	Transformer for 1-3 Philips MR16 Lamps				

Master Value LED MR16 Dimmable



PHILIPS

25,000
HOUR LIFE

2.5
YEAR
WARRANTY
10,000 Hours

IP20

CRI
90

-  Market leading Philips quality LED lamps
-  36° Beam
-  Dimmable



Order No.	Model No.	Base	Wattage (W)	Lumens (lm)	Traditional Equivalent	Colour Temp. (K)
COREPRO LED MR16 NON DIMMABLE						
2501016821	929002492502	MR16	5.8	450	35W	2700K
2501016822	929002492602	MR16	5.8	460	35W	3000K
2501016823	929002492702	MR16	5.8	490	35W	4000K
2501119835	929002493202	MR16	7.5	621	50W	2700K
2501119846	929002493302	MR16	7.5	630	50W	3000K
2501119857	929002493402	MR16	7.5	660	50W	4000K
2500050221	HTM70	Transformer for 1-2 Philips MR16 Lamps				

LED GU10



Bright, efficient and designed to replace traditional incandescent and halogen bulbs, our LED GU10 reflector lamp delivers crisp, natural light with up to 85% less energy use and a long life of up to 15,000 hours. Available in a warm white and cool white colour temperature and standard GU10 base, it provides instant full brightness with no flicker and excellent colour rendering for comfortable, true-to-life illumination. Ideal for living rooms, kitchens, hallways and commercial fixtures, this low-heat, mercury-free lamp cuts running costs and maintenance while offering a familiar PARI6 reflector shape that fits existing fixtures.



Multipacks available from September 2026



Lumen performance equivalent to 50W halogen lamps



Dimmable and Non-Dimmable options available

Order No.	Model No.	Description	Base	Wattage (W)	Lumens (lm)	Efficacy (lm/W)	Colour Temp. (K)
LED GU10							
2503031654	NLGUI03527ND-01	Non-Dimmable	GU10	4.7	380	80	2700K
2503031655	NLGUI03540ND-01	Non-Dimmable	GU10	4.7	380	80	4000K
2503039054	NLGUI03527ND-01/10PK	10 Pack Non-Dimmable	GU10	4.7	380	80	2700K
2503039055	NLGUI03540ND-01/10PK	10 Pack Non-Dimmable	GU10	4.7	380	80	4000K
2503031656	NLGUI03527D-01	Dimmable	GU10	3.7	350	94	2700K
2503031657	NLGUI03540D-01	Dimmable	GU10	3.7	350	94	4000K
2503039056	NLGUI03527D-01/10PK	10 Pack Dimmable	GU10	3.7	350	94	2700K
2503039057	NLGUI03540D-01/10PK	10 Pack Dimmable	GU10	3.7	350	94	4000K

Find out more about our
**Lighting Design
 and Solutions**

See pages 4 & 5 for details
 or email the team today at

lighting.solutions@rexel.co.uk



35mm LED GU10

integral LED

- 36° Beam
- Dimmable

2
YEAR
WARRANTY

IP20

CRI
80



Order No.	Model No.	Base	Wattage (w)	Lumens (lm)	Dimmable	Traditional Equivalent	Colour Temp. (K)
35MM LED GU10							
2450012847	ILMRI1DC011	GU10	3.2	330	Yes	35W	2700K
2450015365	ILMRI1DE012	GU10	3.2	330	Yes	35W	4000K

CorePro LED GU10

PHILIPS

- Market leading Philips quality LED lamps
- 36° Beam
- Dimmable available

15,000
HOUR LIFE

2
YEAR
WARRANTY
8,000 Hours

IP20

CRI
80



Order No.	Model No.	Base	Wattage (w)	Lumens (lm)	Dimmable	Traditional Equivalent	Colour Temp. (K)
COREPRO LED GU10							
2501016793	929001217897	GU10	4	255	No	35W	2700K
2501016794	929001217999	GU10	4	265	No	35W	3000K
2501016796	929001218099	GU10	4	275	No	35W	4000K
2501016797	929001215268	GU10	5	355	No	50W	2700K
2501016798	929001218199	GU10	5	370	No	50W	3000K
2501016799	929001218299	GU10	5	390	No	50W	4000K
2501016800	929001218399	GU10	5	390	No	50W	6500K
2501423452	929002495802	GU10	3	230	Yes	35W	2700K
2503000267	929002068202	GU10	3	230	Yes	35W	3000K
2501423454	929002065602	GU10	3	240	Yes	35W	4000K
2501423455	929002495999	GU10	4	345	Yes	50W	2700K
2501423456	929002068399	GU10	4	345	Yes	50W	3000K
2501423457	929002065899	GU10	4	345	Yes	50W	4000K
2450070570	929003562499	GU10	4	345	Yes	50W	6500K

Order by 5pm for next day delivery

LED T8 Tube



Designed to replace traditional fluorescent lamps, our LED T8 lamp delivers crisp, natural light with up to 85% less energy use and a long life of up to 15,000 hours. Available in a cool white colour temperature and standard G13 base, it provides instant full brightness with no flicker and excellent colour rendering for comfortable, true-to-life illumination. Ideal for many commercial fixtures, this low-heat, mercury-free lamp cuts running costs and maintenance while offering a familiar T8 tube shape that fits existing fixtures.



Works from existing switch start control gear (supplied complete with starter) or direct from the mains



Not suitable for use on high frequency or emergency control gear



Order No.	Model No.	Description	Base	Wattage (W)	Fluorescent Equivalent	Colour Temp. (K)
LED T8 TUBE						
2503031662	NLT82FT40-01	2ft 600mm	G13	9	18W	4000K
2503031663	NLT84FT40-01	4ft 1200mm	G13	17.5	36W	4000K
2503031664	NLT85FT40-01	5ft 1500mm	G13	22.3	58W	4000K
2503031665	NLT86FT40-01	6ft 1800mm	G13	21	70W	4000K

REXEL

Denmans
REXEL GROUP

250+

Branches nationwide

Scan the QR code to find your local branch

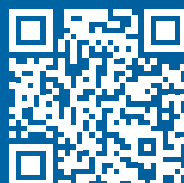

Ultra Efficient LED T8 Tubes

PHILIPS

100,000
HOUR LIFE

10
YEAR
WARRANTY
87,600 Hours

IP20

The new Ultra Efficient range of LED tubes from Signify combine industry leading efficiency of up to 210lm/w with a long 50,000 hour lifetime for a more sustainable lighting solution.

- ✓ Ultra efficient A rated
- 💡 210 lumens per watt



Order No.	Model No.	Description	Wattage (W)	Lumens (lm)	Efficacy (lm/W)	Colour Temp. (K)
ULTRA EFFICIENT LED T8 TUBES						
2501524757	929003482202	1200mm A-Rated Efficiency T8 Tube	11.9	2499	210	4000K
2501524758	929003482302	1500mm A-Rated Efficiency T8 Tube	17.6	3696	210	4000K

CorePro LED Tube

PHILIPS

50,000
HOUR LIFE

3
YEAR
WARRANTY
20,000 Hours

IP20

CRI
80+

For use with electromagnetic/switch start control gear.

- 👍 Market leading Philips quality LED tubes
- ⚡ Not suitable for use on dimming or emergency circuits







Order No.	Model No.	Length (mm)	Wattage (W)	Lumens (lm)	Colour Temp. (K)
COREPRO LED TUBE					
2450070327	929003577132	2ft / 600mm	8	750	3000K
2501618529	929003547202	2ft / 600mm	8	800	4000K
2501618531	929003547302	2ft / 600mm	8	800	6500K
2450070328	929003577232	4ft / 1200mm	15.5	1700	3000K
2501618532	929003519702	4ft / 1200mm	15.5	1800	4000K
2501618533	929003519802	4ft / 1200mm	15.5	1800	6500K
2450070329	929003577332	5ft / 1500mm	20	2050	3000K
2501618534	929003547402	5ft / 1500mm	20	2200	4000K
2501618535	929003547502	5ft / 1500mm	20	2200	6500K
2450070330	929003584702	6ft / 1800mm	21	2900	3000K
2503037199	929004293702	6ft / 1800mm	21	3100	4000K
2503037200	929004293802	6ft / 1800mm	21	3100	6500K

Master LEDtube T5 Mains

PHILIPS



LED Tubes for operation on AC mains connection.

-  Reduced operational cost thanks to lower energy consumption
-  Lower maintenance cost thanks to a longer lifetime than conventional lamps
-  No mercury
-  Not suitable for use on dimming or emergency circuits



Order No.	Model No.	Wattage (W)	Lumens (lm)	Fluorescent Equivalent	Length (mm)	Colour Temp. (K)
HIGH EFFICIENCY						
2503031390	929003795402	7	1000	14W	549mm	3000K
2503031391	929003795502	7	1050	14W	549mm	4000K
2503031392	929003795602	7	1050	14W	549mm	6500K
2450020567	929003044402	16.5	3700	28W	1149mm	3000K
2450020568	929003044502	16.5	3900	28W	1149mm	4000K
2450020569	929003044602	16.5	3900	28W	1149mm	6500K
2450020570	929002421202	20	3700	35W	1449mm	3000K
2450020571	929002421302	20	3900	35W	1449mm	4000K
2450020572	929002421402	20	3900	35W	1449mm	6500K

Order No.	Model No.	Wattage (W)	Lumens (lm)	Fluorescent Equivalent	Length (mm)	Colour Temp. (K)
HIGH OUTPUT						
2501179101	929001908502	26	3700	54W	1149mm	3000K
2501179102	929001908602	26	3900	54W	1149mm	4000K
2501179103	929001908702	26	3900	54W	1149mm	6500K
2501179104	929001908802	26	3700	49W	1449mm	3000K
2501179105	929001908902	26	3900	49W	1449mm	4000K
2501179106	929001909002	26	3900	49W	1449mm	6500K
2501379301	929002474802	36	5200	80W	1449mm	3000K
2501379302	929002474902	36	5600	80W	1449mm	4000K
2501379303	929002475002	36	5600	80W	1449mm	6500K



CorePro LED PLS

PHILIPS

30,000
HOUR LIFE

IP20

CRI
82

-  Operates from existing switch start control gear and AC mains
-  Not suitable for use on dimming or emergency circuits



Order No.	Model No.	Wattage (w)	Base	Lumens (lm)	Traditional Equivalent	Colour Temp. (K)
COREPRO LED PLS						
2503000268	929003756602	3.5	2pin G23	360	7W	3000K
2503000269	929003756702	3.5	2pin G23	390	7W	4000K
2503000270	929003756802	5	2pin G23	520	9/11W	3000K
2503000271	929003756902	5	2pin G23	550	9/11W	4000K

CorePro LED PLC 2pin



PHILIPS

30,000
HOUR LIFE

2
YEAR
WARRANTY
8,000 Hours

IP20

CRI
83

-  Operates from existing switch start control gear and AC mains
-  Not suitable for use on dimming or emergency circuits



Order No.	Model No.	Wattage (w)	Base	Lumens (lm)	Traditional Equivalent	Colour Temp. (K)
COREPRO LED PLC 2PIN						
2503000272	929003757002	5.9	2pin G24d-1	600	10/13W	3000K
2503000273	929003757102	5.9	2pin G24d-1	660	10/13W	4000K
2503000274	929003757202	6.9	2pin G24d-2	700	18W	3000K
2450009105	929003757302	6.9	2pin G24d-2	770	18W	4000K
2503000275	929003757402	8.9	2pin G24d-3	990	26W	3000K
2503000276	929003757502	8.9	2pin G24d-3	1100	26W	4000K

CorePro LED PLC 4pin

PHILIPS

30,000
HOUR LIFE

2
YEAR
WARRANTY
8,000 Hours

IP20

CRI
83

 Operates from existing HF control gear

 Not suitable for use on dimming or emergency circuits



Order No.	Model No.	Wattage (W)	Base	Lumens (lm)	Fluorescent Equivalent	Colour Temp. (K)
COREPRO LED PLC 4PIN						
2503000277	929003757602	5.5	4pin G24q-1	475	10/13W	3000K
2503000278	929003757702	5.5	4pin G24q-1	500	10/13W	4000K
2503000279	929003757802	6.5	4pin G24q-2	650	18W	3000K
2503000280	929003757902	6.5	4pin G24q-2	700	18W	4000K
2503000281	929003758002	9.5	4pin G24q-3	950	26W	3000K
2503000282	929003758102	9.5	4pin G24q-3	1000	26W	4000K

CorePro LED PLT 4pin

PHILIPS

30,000
HOUR LIFE

2
YEAR
WARRANTY
8,000 Hours

IP20

CRI
82

 Operates from existing HF control gear



 Not suitable for use on dimming or emergency circuits



Order No.	Model No.	Wattage (W)	Base	Lumens (lm)	Fluorescent Equivalent	Colour Temp. (K)
COREPRO LED PLC 4PIN						
2450070556	929003576302	6.5	4pin GX24q-2	720	18W	3000K
2450070557	929003576402	6.5	4pin GX24q-2	800	18W	4000K
2450070558	929003576502	9	4pin GX24q-3	990	26W	3000K
2450070559	929003576602	9	4pin GX24q-3	1100	26W	4000K
2450070560	929003576702	15	4pin GX24q-3	1620	32W	3000K
2450070561	929003576802	15	4pin GX24q-3	1800	32W	4000K
2450070562	929003576902	18.5	4pin GX24q-4	2100	42W	3000K
2450070563	929003577002	18.5	4pin GX24q-4	2250	42W	4000K

CorePro LED PLL

PHILIPS

-  Operates direct from existing AC mains
-  Not suitable for use on dimming or emergency circuits



30,000 HOUR LIFE	2 YEAR WARRANTY 8,000 Hours	IP20	CRI 80
----------------------------	---	-------------	-------------------

Order No.	Model No.	Wattage (w)	Base	Lumens (lm)	Fluorescent Equivalent	Colour Temp. (K)
COREPRO LED PLL						
2450070548	929003592202	8	2G11	960	18W	3000K
2450070549	929003592302	8	2G11	1000	18W	4000K
2450070550	929003592402	12	2G11	1440	24W	3000K
2450070551	929003592502	12	2G11	1500	24W	4000K
2450070552	929003592602	16.5	2G11	2000	36W	3000K
2450070553	929003592702	16.5	2G11	2100	36W	4000K
2450070554	929003592802	24	2G11	3200	55W	3000K
2450070555	929003592902	24	2G11	3400	55W	4000K

Discover our Industrial Solutions

Contact the specialist team today at Industrial.enquiries@rexel.co.uk

Call **0330 045 0606**

Or scan the QR code for more information

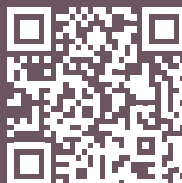

2D LED Replacement

5
YEAR
WARRANTY

IP20

Kosnic's range of LED DD lamps takes a fresh approach to functional lighting with a design philosophy offering compatible emergency packs and microwave sensor so that there are no barriers to retrofitting LEDs in commercial fittings.

 Wattage and colour temperature switchable

 Replaces 16W, 28W and 38W fluorescent 2D lamps

 Flicker free



Order No.	Model No.	Wattage (W)	Base	Fluorescent Equivalent	Colour Temp. (K)
2D LED REPLACEMENT					
2501632638	DD212/4P-SCT	6/8/10/12	4pin GR10q	16W	2700/4000/6500K
2501632649	DD218/2P-SCT	9/12/15/18	2pin GR8	28W	2700/4000/6500K
2501632660	DD218/4P-SCT	9/12/15/18	4pin GR10q	28/38W	2700/4000/6500K
2503033993	EMDD202/SST	Emergency Module to Suit (Manual & Self-Test Selectable)			
2501630833	RMW-DC	Plug-In Microwave Sensor			
2450069875	RMT-UNI	Universal Remote Control for Kosnic Microwave Sensors			

TrueForce SON-T Replacement

PHILIPS

25,000
HOUR LIFE

3
YEAR WARRANTY
12,000 Hours

IP65



- Similar look and feel to conventional SON-T lamps
- Perfect fit in HID luminaires
- Works directly from AC mains

Order No.	Model No.	Base	Wattage (W)	Lumens (lm)	Traditional Equivalent	Colour Temp. (K)
TRUEFORCE SON-T REPLACEMENT						
2450018325	929002484802	ES (E27)	17	2800	50W SON-T	3000K
2450018326	929002484902	ES (E27)	17	3000	50W SON-T	4000K
2503049294	929004341302	ES (E27)	26	4200	70W SON-T	3000K
2503049295	929004341402	ES (E27)	26	4500	70W SON-T	4000K
2450018329	929002485202	GES (E40)	40	7200	100W SON-T	3000K
2450018330	929002485302	GES (E40)	40	7500	100W SON-T	4000K

LED Corn Lamp

BRIGHT SOURCE

The Bright Source LED Corn Lamp are powerful and efficient solutions for commercial and industrial lighting applications, delivering bright and uniform illumination across large spaces. Designed with a 360° beam angle, this corn-style lamp ensures even light distribution, eliminating dark spots and improving overall visibility.

1
YEAR WARRANTY
with registration

IP64



- Aluminium heat sink - no internal fan required
- Up to 73% energy saving vs traditional HQI lamps
- No control gear required - direct to mains

Order No.	Model No.	Description	Base	Wattage (W)	Lumens (lm)	Traditional Equivalent	Dimensions (mm)	Colour Temp. (K)
LED CORN LAMP								
2450068704	247487	20W Corn Lamp	ES (E27)	20	2250	70W SON	60x148	6000K
2450068708	247500	30W Corn Lamp	ES (E27)	30	2250	100W SON	60x173	6000K
2450068709	247494	30W Corn Lamp	GES (E40)	30	3900	100W SON	60x188	6000K
2450068711	247524	40W Corn Lamp	ES (E27)	40	5200	150W SON	85x195	6000K
2450068712	247517	40W Corn Lamp	GES (E40)	40	5200	150W SON	85x216	6000K
2450068714	247548	60W Corn Lamp	GES (E40)	60	7800	200W SON	85x255	6000K
2450068716	247555	80W Corn Lamp	GES (E40)	80	10,400	250W SON	130x255	6000K
2450068718	247562	100W Corn Lamp	GES (E40)	100	13,000	350W SON	130x267	6000K
2450068720	247579	120W Corn Lamp	GES (E40)	120	15,600	400W SON	130x288	6000K
2450068721	247111	150W Corn Lamp	GES (E40)	150	20,250	450W SON	128x315	6000K
2450068722	247128	200W Corn Lamp	GES (E40)	200	29,000	600W SON	128x335	6000K
2450068723	247135	240W Corn Lamp	GES (E40)	240	34,800	750W SON	140x335	6000K

REXEL

POWERING DREAMS THROUGH PARTNERSHIPS

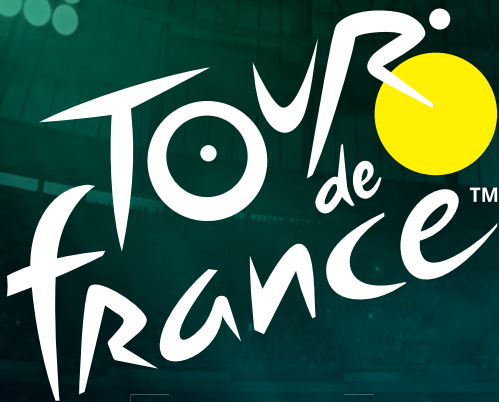

OFFICIAL
PARTNER



OFFICIAL ELECTRICAL
WHOLESALE



OFFICIAL CLUB PARTNER

Sustainably Electrifying
Sport At *ALL* Levels

Discover more at rexel.co.uk

16 | Lighting Connection & Distribution

Scan here to see our
full range online



Lighting Control Module Kits

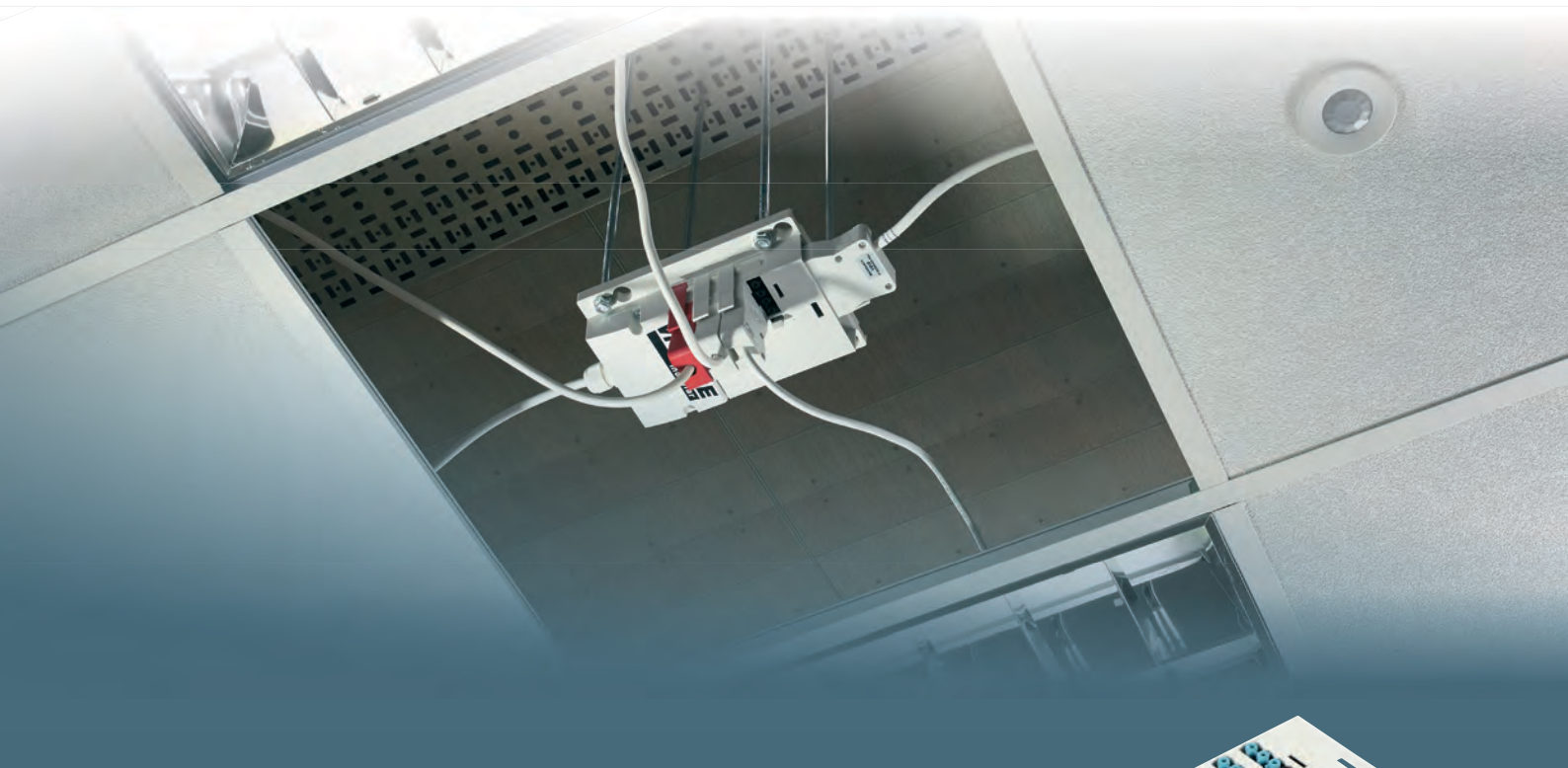

Vitesse lighting control modules are a cost effective method of providing luminaire power and control for lighting installations in industrial, commercial and retail buildings. Modules work in combination with CP Electronics presence detectors and allow groups of luminaires to be controlled by a single detector.



 Room by room, floor by floor lighting connection and control

 Lux level sensing

 Switching or dimming

Order No.	Model No.	Description
LIGHTING CONTROL MODULE KITS		
2503024276	AP-VITM4-6-KIT	Vitesse Modular Kit 4 pole / 6 outputs
2503024277	AP-VITM4-8-KIT	Vitesse Modular Kit 4 pole / 8 outputs
2503024278	AP-VITM4-10-KIT	Vitesse Modular Kit 4 pole / 10 outputs
2503024271	AP-VITM4-12-KIT	Vitesse Modular Kit 4 pole / 12 outputs
2503024272	AP-BVITM6-6-KIT	Vitesse Modular Kit 6 pole / 6 outputs
2503024273	AP-BVITM6-8-KIT	Vitesse Modular Kit 6 pole / 8 outputs
2503024274	AP-BVITM6-10-KIT	Vitesse Modular Kit 6 pole / 10 outputs
2503024275	AP-BVITM6-12-KIT	Vitesse Modular Kit 6 pole / 12 outputs

Marshalling Boxes



Klik marshalling boxes are used in conjunction with Klik 3 and 4 pin plugs to connect luminaires within an area. The Klik marshalling box can be separated into two independently switched circuits. These circuits can be controlled via wall switch or occupancy sensor.



- Complies with BS 5733:2010.
- Main terminal rating: 16 Amps.
- Socket outlet rating: 6 Amps.
- Separate terminals for flexible conductors, rating: 10 Amps.
- Short circuit tested 1500A conditional rating.
- Socket outlets accept either Klik lighting (3 pin) plugs, Klik auxiliary (4 pin) plugs.

Order No.	Model No.	Description
-----------	-----------	-------------





MARSHALLING BOXES

2500099037	KLDS4	4 Way
2500065556	KLDS6	6 Way
2500065557	KLDS8	8 Way
2500065558	KLDS10	10 Way
2500163774	KLDS12	12 Way

Pre-wired Plug-in Ceiling Roses 3pin

:hager

6A pre-wired plug-in ceiling roses are used to connect luminaires to a fixed wiring installation.

-  Complies with BS 6972 and BS 5733:2010
-  PVC flexible cord complies with BS EN 50525-2-11
-  Low smoke zero halogen flexible cord, complies with BS EN 50525-3-11
-  All leads have prepared ends







Order No.	Model No.	Description
PRE-WIRED PLUG-IN CEILING ROSES 3PIN		
2500067588	PCR2000/1.0	0.75mm PVC 1 metre
2500067632	PCR2000/2.0	0.75mm PVC 2 metre
2500067633	PCR2000/3.0	0.75mm PVC 3 metre
2500067692	PCR2000/4.0	0.75mm PVC 4 metre
2500067631	PCR2000/1.0PVC/5	1mm PVC 5 metre
2500067694	PCR2000/LSF/2.0	0.75mm LSZH 2 metre
2500067695	PCR2000/LSF/3.0	0.75mm LSZH 3 metre
2500067589	PCR2000/1.0LSF/2	1mm LSZH 2 metre
2500067590	PCR2000/1.0LSF/3	1mm LSZH 3 metre
2500067611	PCR2000/1.0LSF/5	1mm LSZH 5 metre

Pre-wired Plug-in Ceiling Roses 4pin

:hager

Auxiliary 6A pre-wired plug-in ceiling roses are used to connect luminaires to a fixed wiring installation.

-  Complies with BS 6972 and BS 5733:2010
-  PVC flexible cord complies with BS EN 50525-2-11
-  Low smoke zero halogen flexible cord, complies with BS EN 50525-3-11
-  All leads have prepared ends



Order No.	Model No.	Description
PRE-WIRED PLUG-IN CEILING ROSES 4PIN		
2500065509	CR64AX/1.0	0.75mm PVC 1 metre
2500065534	CR64AX/2.0	0.75mm PVC 2 metre
2500065535	CR64AX/3.0	0.75mm PVC 3 metre
2500065536	CR64AX/4.0	0.75mm PVC 4 metre
2500065533	CR64AX/1.0PVC/5	1mm PVC 5 metre
2500065544	CR64AX/LSF/1.0	0.75mm LSZH 1 metre
2500065545	CR64AX/LSF/2.0	0.75mm LSZH 2 metre
2500065546	CR64AX/LSF/3.0	0.75mm LSZH 3 metre
2500065510	CR64AX/1.0LSF/2	1mm LSZH 2 metre
2500065511	CR64AX/1.0LSF/3	1mm LSZH 3 metre
2500065521	CR64AX/1.0LSF/5	1mm LSZH 5 metre

3 Pin Pre-wired 6A Plugs

:hager

6A pre-wired plugs are used to connect luminaires to a Klik ceiling rose or marshalling box. All leads have prepared ends.

- Complies with BS 6972 and BS 5733:2010
- PVC flexible cord complies with BS EN 50525-2-II
- Low smoke zero halogen flexible cord, complies with BS EN 50525-3-II



Order No.	Model No.	Description
3 PIN PRE-WIRED 6A PLUGS		
2500065606	P22/2.0	0.75mm PVC 2 metre
2500065607	P22/3.0	0.75mm PVC 3 metre
2500065909	P22/4.0	0.75mm PVC 4 metre
2500065575	P22/1.0PVC/3.0	1mm PVC 3 metre
2500065605	P22/1.0PVC/5.0	1mm PVC 5 metre
2500065912	P22/LSF/3.0	0.75mm LSZH 3 metre
2500065567	P22/1.0LSF/3.0	1mm LSZH 3 metre
2500065573	P22/1.0LSF/5.0	1mm LSZH 5 metre

4 Pin Pre-wired 6A Plugs

:hager

Klik auxiliary 6A pre-wired plugs are used to connect luminaires to a Klik ceiling rose or marshalling box.

- Complies with BS 6972 and BS 5733:2010
- PVC flexible cord complies with BS EN 50525-2-II
- Low smoke zero halogen flexible cord, complies with BS EN 50525-3-II
- All leads have prepared ends







Order No.	Model No.	Description
4 PIN PRE-WIRED 6A PLUGS		
2500066106	P64AX/2.0	0.75mm PVC 2 metre
2500066259	P64AX/3.0	0.75mm PVC 3 metre
2500066105	P64AX/1.0PVC/5	1mm PVC 5 metre
2500066314	P64AXR/2.0	0.75mm PVC 2 metre
2500066315	P64AXR/3.0	0.75mm PVC 3 metre
2500066316	P64AXR/4.0	0.75mm PVC 4 metre
2500066304	P64AXR/1.0PVC/5	1mm PVC 5 metre
2500066346	P64AXR/LSF/3.0	0.75mm LSZH 3 metre
2500066290	P64AXR/1.0LSF/3	1mm LSZH 3 metre
2500066292	P64AXR/1.0LSF/5	1mm LSZH 5 metre

Plug-in Ceiling Roses & Covers

:hager

The 6A plug-in ceiling rose is used to offer a pluggable connection for luminaires. The luminaire can be connected and disconnected under load. Red variants include auxiliary, typically used for emergency lighting.

-  Complies with BS 5733:2010.
-  Sockets have 4 terminations: line, neutral, CPC and loop-in. (Red variants have extra auxiliary socket)
-  Plugs have 3 terminations: line, neutral and CPC. (Red variants have extra auxiliary termination)
-  Fixing: 50.8mm Standard Diagonal (BESA)







Order No.	Model No.	Description
PLUG-IN CEILING ROSES & COVERS		
2500066348	PCR2000	3 Pin Plug-in Ceiling Rose
2501354999	PCR2000BLACK	3 Pin Plug-in Ceiling Rose
2500065500	CR64AX	4 Pin Plug-in Ceiling Rose
2500190601	CR64AX/R	4 Pin Plug-in Ceiling Rose
2500065499	A1	Spare Ceiling Rose Cover
2500099036	A1/R	Spare Ceiling Rose Cover

Plugs & Sockets

:hager

Klik 3 pin plugs are used to connect into a Klik socket giving a pluggable connection to luminaires.



-  Complies with BS 6972 and BS 5733:2010
-  Suitable for use with any Klik 3 or 4 pin socket
-  3 pin Plugs have 3 terminations: line, neutral and CPC
-  4 pin Plugs have 4 terminations: line, neutral, CPC and auxiliary

Warning: Plugs must not be fitted on the supply side of any installation - they must be connected to the load/fitting/appliance side of the installation.



Order No.	Model No.	Description
PLUGS & SOCKETS		
2500065564	P22	3 Pin Plug
2500066081	P64AX	4 Pin Plug
2500066273	P64AX/R	4 Pin Plug
2500067775	S27	3 Pin Socket
2500068058	S64AX	4 Pin Socket

Lighting Control Modules

-  Connect any LightspotHD Detector
-  Available in a choice of sizes for dimmable or fixed output luminaires
-  Choice of leads - LSOH and terminated with a 6 or 7-way Wieland GST-style locking connector



Order No.	Model No.	Description
LIGHTING CONTROL MODULES		
2500964417	CDW4U1UL	4 x 6-Pole Luminaire Sockets + 1 x 7-Pole Presence Detector Input Port
2500964418	CDW6U1UL	6 x 6-Pole Luminaire Sockets + 1 x 7-Pole Presence Detector Input Port
2500513268	CDW10U2UL	10 x 6-Pole Luminaire Sockets + 2 x 7-Pole Presence Detector Input Ports
2500378079	CDW12U5-BDALI	Connect Digital Intelligent Lighting Control Module, 12 luminaires, 5 detectors and 5 switch inputs



Luminaire and Sensor Leads



Order No.	Model No.	Description
LUMINAIRE AND SENSOR LEADS		
2500360507	CPWL633	Connect 3m Luminaire Connector - 6-Pin/3-Core, Wieland Gst 18/6 with Locking Mechanism
2500360508	CPWL635	Connect 5m Luminaire Connector - 6-Pin/3-Core, Wieland Gst 18/6 with Locking Mechanism
2500360519	CPWL653	Connect 3m Luminaire Connector - 6-Pin/5-Core, Wieland Gst 18/6 with Locking Mechanism
2500360520	CPWL655	Connect 5m Luminaire Connector - 6-Pin/5-Core, Wieland Gst 18/6 with Locking Mechanism
2500837556	LSHDSLW753	Lightspot HD Switching Lead Wieland 7pin 5-Core 3 metre
2500837552	LSHDSLW763	Lightspot HD Dimming And Switching Lead Wieland 7pin 6-Core 3m
2500359403	BT5E050GY	Connect Digital Sensor Patch Lead - 5m

Commissioning Tools

Designed for simple and flexible programming and control of your LightspotHD products.

-  QuickSetPro - for commissioning and recommissioning with virtually no disturbance to occupants
-  QuickSet - 4 time delay settings, presence/absence detection, walk test feature
-  QuickControl - ideal for daily use e.g. on/off override, brightness control, 6 scene settings







Order No.	Model No.	Description
COMMISSIONING TOOLS		
1051052633	QuickSetPro	LightSpot HD Digital 2-Way Programming Tool
2500671808	QuickSet	LightSpot HD Infrared Programming Tool
2500671806	QuickControl	LightSpot HD Infrared User Controller (can be wall mounted)

Lighting Connector Plugs



A range of 20A lighting connectors for quick and easy installation of light fittings.



-  Easy lock and release system
-  Large terminals for easy access
-  For use with 2.5mm² cable
-  4 Pole with Push-Fit Quick Click available on request from September 2024



Order No.	Model No.	Description
LIGHTING CONNECTOR PLUGS		
2500820112	LCGN3P	3 Pole + 1
2501129533	LCGN4P	4 Pole
2501303220	LCGN3PLS	3 Pole with Push-Fit Quick Click Terminals

Ask us about our
MASSIVE
Cable Offer

Includes cut lines!



17 | Lighting Controls



Scan here to see our
full range online





Wall & Ceiling Mounted Occupancy Detectors



Presence detectors (occupancy detectors) are designed to reduce the amount of time lighting is left on unnecessarily.



 A presence detector monitors the detection zone for occupancy; if a person is sensed then the detector will automatically turn the lighting on

 Controlling lighting with a presence detector can save up to 60% of lighting energy costs dependent on occupancy behaviour and the amount of natural light available

 NLPIR-RECESS & NLMWS cutout size 65mm







Order No.	Model No.	Description	Detection Distance
WALL & CEILING MOUNTED OCCUPANCY DETECTORS			
2501673867	NLPIR-RECESS	Occupancy Detector Ceiling PIR Recess Mount	12m
2501673868	NLPIR-SURFACE	Occupancy Detector Ceiling PIR 3 Surface Mount	12m
2501673870	NLPIR-WALL2W	Occupancy Detector Wall PIR 2 Wire	12m
2501673869	NLPIR-WALL3W	Occupancy Detector Wall PIR 3 Wire	12m
2501673871	NLMWS	Microwave Motion Sensor	12m

Exterior PIR Sensors



A standalone PIR range designed for external usage only on residential properties. They offer energy efficiency by reducing light usage while also offering security.



-  Moveable detector allows horizontal and vertical adjustment
-  Lens can be masked to reduce nuisance detection
-  Adjustable time from 5 seconds to 5 minutes
-  Adjustable lens angle to optimise detection zone
-  Manual override functions available

Order No.	Model No.	Colour	Detection Angle	LED Switching Capacity (W)	IP Rating
EXTERIOR PIR DETECTORS					
1050378531	NLPIRB1A	Black	140°	100	IP44
1050378532	NLPIRW1A	White	140°	100	IP44
1050378533	NLPIRB2A	Black	180°	100	IP55
1050378534	NLPIRW2A	White	180°	100	IP55



Green-i™

FLEXIBILITY MEETS SIMPLICITY!



Standalone detectors
for all requirements

DISCOVER THE NEW CP ELECTRONICS RANGE OF GREEN-i™ DETECTORS

Offering intuitive installation,
versatile design and excellent
performance. This enhanced range
provides optimal user comfort
and improved aesthetics to fit
seamlessly into any environment.

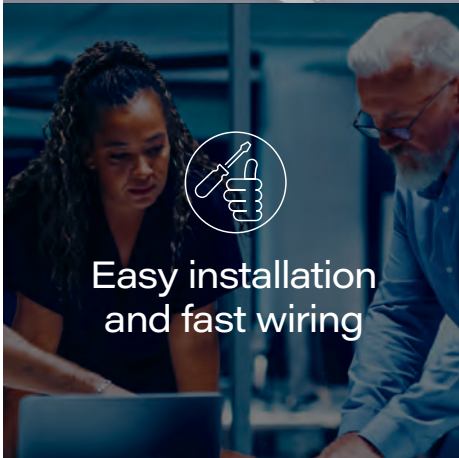

Easy installation
and fast wiring

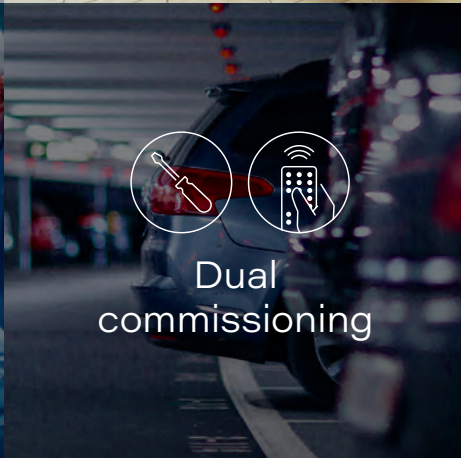

Dual
commissioning



Wholesale
friendly range

VITESSE CLASSROOM KITS



CLASSROOM
LIGHTING CONTROL
- IN ONE BOX

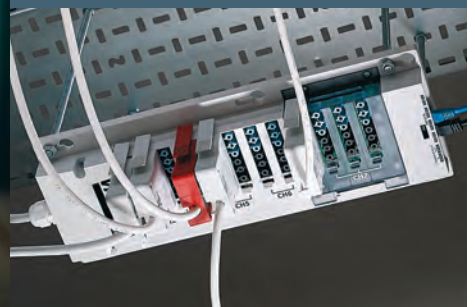

VITESSE LIGHTING CONTROL MODULES



INTERESTED IN STOCKING
OUR PRODUCTS?

Contact your local wholesale
representative today!

Visit: legrand.co.uk/en/wholesale-map

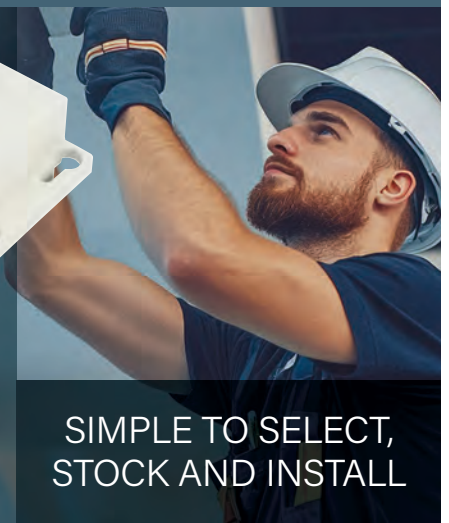

SIMPLE TO SELECT,
STOCK AND INSTALL

CP Electronics
A brand of  **legrand**







Green-i Sensor Range

CP Electronics
A brand of **legrand**

5
YEAR
WARRANTY

10
YEAR
EXPECTED LIFE

Discover the new CP Electronics range of Green-i™ detectors, offering intuitive installation, versatile design and excellent performance. This enhanced range provides optimal user comfort and improved aesthetics to fit seamlessly into any environment.

-  Presence and absence detection
-  On/Off variants adjustable 10 seconds to 30 minute time delay
-  DALI variants adjustable 10 seconds to 45 minutes time delay
-  Adjustable light level from 5 to 2000 lux
-  Configure detectors manually or with a handset
-  Low standby consumption 0.1W
-  PIR (Passive Infrared) technology



GEMIP-G



GEMB-W



GESM-B



GENB-W



GEHBFL-B







GE-HS

Order No.	Model No.	Description	Detection Angle	Detection Pattern	IP Rating	Colour
GREEN-I SENSOR RANGE						
2503038826	GEFL-W	Recessed On/Off	360°	Ø 14 metres	IP41	White
2503037079	GEFL-W-DD	Recessed DALI	360°	Ø 14 metres	IP41	White
2503037085	GEFL-B	Recessed On/Off	360°	Ø 14 metres	IP41	Black
2503037086	GEFL-B-DD	Recessed DALI	360°	Ø 14 metres	IP41	Black
2503037083	GESM-W	Surface Mount On/Off	360°	Ø 14 metres	IP40	White
2503037084	GESM-W-DD	Surface Mount DALI	360°	Ø 14 metres	IP40	White
2503037087	GESM-B	Surface Mount On/Off	360°	Ø 14 metres	IP40	Black
2503037088	GESM-B-DD	Surface Mount DALI	360°	Ø 14 metres	IP40	Black
2503037102	GEMR-W	Recessed Mini On/Off	360°	Ø 9 metres	IP20	White
2503037104	GEMR-W-DD	Recessed DALI	360°	Ø 9 metres	IP20	White
2503037103	GEMR-B	Recessed Mini On/Off	360°	Ø 9 metres	IP20	Black
2503037105	GEMR-B-DD	Recessed DALI	360°	Ø 9 metres	IP20	Black
2503037089	GEWIP-W	Wall Mounted	140°	Ø 14 metres	IP55	White
2503037070	GEWIP-G	Wall Mounted	140°	Ø 14 metres	IP55	Graphite
2503037071	GEMIP-G	Ceiling Mounted	360°	Ø 8 metres	IP55	Graphite
2503037072	GENB-W	Recessed Corridor On/Off	360°	Ø 5 metres x 24 metres	IP41	White
2503037073	GENB-B	Recessed Corridor On/Off	360°	Ø 5 metres x 24 metres	IP41	Black
2503037074	GENBSM-W	Surface Mount Corridor On/Off	360°	Ø 5 metres x 24 metres	IP40	White
2503037075	GENBSM-B	Surface Mount Corridor On/Off	360°	Ø 5 metres x 24 metres	IP40	Black
2503037076	GEMB-W	Batten Mount On/Off	360°	Ø 9 metres	IP65	White
2503037077	GEHBFL-W	Recessed High Bay On/Off	360°	Ø 20 metres	IP41	White
2503037078	GEHBFL-B	Recessed High Bay On/Off	360°	Ø 20 metres	IP41	Black
2503037080	GEHBSM-W	Surface Mount High Bay On/Off	360°	Ø 20 metres	IP55	White
2503037081	GEHBSM-B	Surface Mount High Bay On/Off	360°	Ø 20 metres	IP55	Black
2503037082	GE-HS	Infrared Remote Control				

PIR Detectors

Lightspot HD PIR Detectors provide an effective and flexible light control solution to enhance the environment and better manage energy.





-  Cost effective, reliable occupancy detection
-  Integrated daylight sensing
-  Quick, easy commissioning with simple local controls
-  Ideal for offices, corridors, toilets and storage areas



Order No.	Model No.	Description
PIR DETECTORS		
2503000782	LS1000U	LightSpot Switching Sensor. Dual Flush and Surface Mount.
2500671773	LS3100RF	LightSpot HD Switching Sensor with Manual Override. Flush Mount.
2500671758	LS3000DRF	LightSpot HD Digital Dimming Sensor with Relay. Flush Mount
2500837563	MLS3000CDRF	Digital Connect DALI Dimming 360° PIR detector Flush Mount

Microwave Detectors

Lightspot HD Microwave Detectors use microwave technology enabling them to be adjusted for a tailored detection pattern to suit any application.

-  Flush and surface mounting options
-  Dimming versions incorporate terminals for optional OneSwitch dimming
-  360 degree detectors ideal for offices, open-plan workstations, classrooms
-  Directional detectors ideal for larger classrooms, long corridors, storage aisles



Order No.	Model No.	Description
PIR DETECTORS		
2501515375	MLS3500CDRF	Digital Connect DALI dimming directional Microwave detector flush corner mount
2501515244	MR3500RF	LightSpot HD Compact Switching Directional Microwave Presence Detector, 1 Volt Free Output. Flush Corner Mounted
2501515243	MR3500DRF	LightSpot HD Compact DALI/DSI Dimming/Switching Directional Microwave Presence/Absence Detector. Flush Corner Mount.

Outdoor Sensors



IP65

Steinel are world renowned for the quality and design finesse of their PIR sensor range. It is now accepted by everyone that the future of lighting must be automatic. Steinel have embraced this philosophy for both indoor and outdoor lighting whilst also keeping their focus on aesthetics ensuring that 'tomorrow's technology' is not only a green and efficient option but also an attractive option for your home.



- PIR (Passive Infrared) Technology
- Adjustable time and lux settings
- Suitable for indoor and outdoor use
- Black and white body colours available
- Optimum 2m mounting height



Order No.	Model No.	Description	Colour	Detection Angle	LED Switching Capacity (W)	IP Rating
OUTDOOR SENSORS						
2500222929	600419	10m Detection Distance	Black	120°	64	IP54
2500222928	600310	10m Detection Distance	White	120°	64	IP54
2500968493	34689	14m Detection Distance	Black	140°	300	IP54
2500968489	34672	14m Detection Distance	White	140°	300	IP54
2500046068	602710	12m Detection Distance	Black	240°	300	IP54
2500046069	602819	12m Detection Distance	White	240°	300	IP54
2500968496	34702	12m Detection Distance	Black	180°	300	IP54
2500968494	34696	12m Detection Distance	White	180°	300	IP54

Photocells



A range of light operated switches that switch the supply ON to a luminaire when the light level falls under a pre-set value (usually dusk) and switches the supply OFF when it rises above a pre-set level (usually dawn). Photocells help to drive down costs and improve energy efficiencies by ensuring lights are not on when not needed.



- UV stabilised polycarbonate construction
- Photocell Kit includes; Photocell, NEMA socket, gasket, wall mounting bracket and fixing screws
- Operating voltage 198-264V 50 Hz
- NL5605**
- Heavy duty load switching capacity and surge suppression

Order No.	Model No.	Description	Max Load LED	Switch On/Off Light Level (Lux)	Sensor	Switching Operations	Operating Temperatures
PHOTOCELLS							
1000005886	NL5600	Photocell	1000W (4A)	70/105	Photodiode	10000	-20°C to + 70°C
1000015760	NL5601	Photocell Kit	1000W (4A)	70/105	Photodiode	10000	-20°C to + 70°C
1050150455	NL5605	Surge Suppressed Photocell Kit	1500W (6A)	70/35	PhotoIC	25000	-20°C to + 80°C

Wall Mount Photocell



The NightOwl is a compact light sensitive controller, designed to automatically switch on your lighting through a photo electric cell with easily adjustable, variable settings. Ideally suitable for the control of lights at the front door, garden, garage etc.



- Has a time delay circuit, not affected cloud cover, reflections, vehicle lights or lighting
- Two configurable setting options:
 - Dusk to dawn
 - Fixed time
- Wall mountable

Order No.	Model No.	Description
WALL MOUNT PHOTOCELL		
2501683074	WDF5000R	Wall Mount Compact Photocell

Miniature Photocells



A range of light operated switches that switch the supply ON to a luminaire when the light level falls under a pre-set value (usually dusk) and switches the supply OFF when it rises above a pre-set level (usually dawn). Photocells help to drive down costs and improve energy efficiencies by ensuring lights are not on when not needed.

Consumes less than 0.25W (Day & Night)

IP65 when installed correctly

NL5608
20mm sensor/mounting stud

NLSS14R
20mm remote sensor

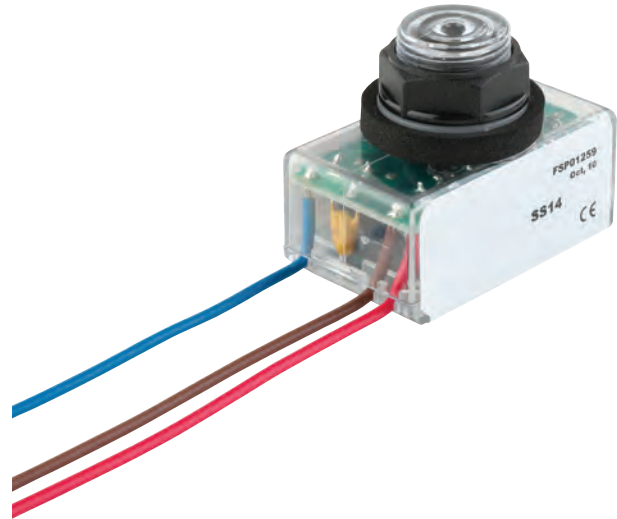

Order No.	Model No.	Description	Max Load LED	Switch On/Off Light Level (Lux)	Sensor	Switching Operations	Operating Temperatures
MINIATURE PHOTOCELLS							
1050334793	NL5608	Mini Photocell	1000W (4A)	70/105	Photodiode	10000	-20°C to + 75°C
1051059427	NLSS14R	Mini Remote Photocell	1000W (4A)	70/105	Photodiode	10000	-20°C to + 75°C

Photocells



Helping drive down costs and improve energy efficiencies, the Lucy Zodion photocell range is extensive to suit most lantern designs and switching requirements. With a portfolio of one and two-part, miniature, full and part-night versions, the quality range ensures high switching accuracy for a number of applications.



Order No.	Model No.	Description
PHOTOCELLS		
2501683071	F6054R	NEMA Photocell. 20lx On/Off. 400W LED Switching Capacity. 4 Year Warranty.
2501683072	F7020-0022-35R	Part Night NEMA Photocell. 12:00am - 5:30am Off. 250W LED Switching Capacity. 35lx On / 18lx Off. 6 Year Warranty
2501683073	F6253-0004R	Zcell NEMA Photocell. 20lx On/Off. 400W LED Switching Capacity
2501683076	F3060R	Mounting Kit for NEMA Photocells

18 | Lighting Control Gear & Accessories



7.0
9,55
TREPPE

INST.-SCHACHT

Scan here to see our
full range online



Indoor Constant Voltage LED Drivers





Constant voltage drivers suitable for use with LED strip lights or other LED light sources that require a constant 12V or 24V supply. Available in 12V or 24V DC outputs, they have both input and output terminals to make wiring easier.

50,000
HOUR LIFE

IP20



-  12V and 24V constant voltage options available
-  Non dimmable
-  Over load, short circuit and thermal protection

Order No.	Model No.	Description	Voltage (v)	Wattage (w)
INDOOR CONSTANT VOLTAGE LED DRIVERS				
2450006501	PCV1212	Indoor Constant Voltage LED Driver	12V	12W
2450006502	PCV1220	Indoor Constant Voltage LED Driver	12V	20W
2450006505	PCV1236-REV-A	Indoor Constant Voltage LED Driver	12V	36W
2450006506	PCV1250-REV-A	Indoor Constant Voltage LED Driver	12V	50W
2450019825	PCV1261	Indoor Constant Voltage LED Driver	12V	60W
2450006509	PCV12100-REV-C	Indoor Constant Voltage LED Driver	12V	100W
2450013297	PCV12150-REV-D	Indoor Constant Voltage LED Driver	12V	150W
2450006503	PCV2420	Indoor Constant Voltage LED Driver	24V	20W
2450006504	PCV2436-REV-A	Indoor Constant Voltage LED Driver	24V	36W
2450006507	PCV2450-REV-A	Indoor Constant Voltage LED Driver	24V	50W
2450070597	PCV2461	Indoor Constant Voltage LED Driver	24V	60W
2450006508	PCV2475	Indoor Constant Voltage LED Driver	24V	75W
2450006510	PCV24100-REV-C	Indoor Constant Voltage LED Driver	24V	100W
2450008780	PCV24150-REV-D	Indoor Constant Voltage LED Driver	24V	150W

Find out more about our
**Lighting Design
and Solutions**

See pages 4 & 5 for details
or email the team today at

lighting.solutions@rexel.co.uk



Outdoor Constant Voltage LED Drivers



Constant voltage drivers suitable for use with LED strip lights or other LED light sources that require a constant 12V or 24V supply.

50,000
HOUR LIFE

IP65

- 12V and 24V constant voltage options available
- Non dimmable
- Over load, short circuit and thermal protection
- Pre-wired to help maintain IP rating



Order No.	Model No.	Description	Voltage (v)	Wattage (w)
INDOOR CONSTANT VOLTAGE LED DRIVERS				
2450008158	PCVI236E-REV-A	Outdoor Constant Voltage LED Driver	12V	36W
2450012882	PUC-V06C-REV-B	Outdoor Constant Voltage LED Driver	12V	60W
2450006511	PCVI275E-REV-A	Outdoor Constant Voltage LED Driver	12V	75W
2450011346	PCVI2200E-REV-A	Outdoor Constant Voltage LED Driver	12V	200W
2450012897	PCVI2264E	Outdoor Constant Voltage LED Driver	12V	264W
2450013387	PCV2436E-REV-A	Outdoor Constant Voltage LED Driver	24V	36W
2450012883	PUC-V06G-REV-B	Outdoor Constant Voltage LED Driver	24V	60W
2450006512	PCV2475E-REV-A	Outdoor Constant Voltage LED Driver	24V	75W
2450006513	PCV24150E-REV-A	Outdoor Constant Voltage LED Driver	24V	150W
2450012894	PCV24200E-REV-A	Outdoor Constant Voltage LED Driver	24V	200W
2450012896	PCV24240E-REV-A	Outdoor Constant Voltage LED Driver	24V	240W
2450012898	PCV24320E	Outdoor Constant Voltage LED Driver	24V	320W

Triac Dimmable Constant Voltage LED Drivers



UVC Series are a range of constant voltage Triac dimming LED lighting power supplies. Compatible with leading and trailing edge dimmers these LED drivers have a 10-100% dimming range.

50,000
HOUR LIFE

IP20

- Push fit terminals for easy installation
- Short circuit, over current and over voltage protection
- Minimum 10% load required



Order No.	Model No.	Description	Voltage (v)	Wattage (w)
INDOOR CONSTANT VOLTAGE LED DRIVERS				
2450008204	UVC1225TD	TRIAC Dimmable Constant Voltage LED Drivers	12V	25W
2450010314	UVC1250TD	TRIAC Dimmable Constant Voltage LED Drivers	12V	50W
2450013390	UVC12100TD	TRIAC Dimmable Constant Voltage LED Drivers	12V	100W
2450010315	UVC2425TD	TRIAC Dimmable Constant Voltage LED Drivers	24V	25W
2450010316	UVC2450TD	TRIAC Dimmable Constant Voltage LED Drivers	24V	50W
2450013391	UVC24100TD	TRIAC Dimmable Constant Voltage LED Drivers	24V	100W

Constant Current LED Drivers



TRIDONIC

5
YEAR
WARRANTY

100,000
HOUR LIFE

IP20

NEW

-  Switchable output currents via DIP switches
-  Overload, short circuit, no-load and temperature protection
-  2kV Surge protection



Order No.	Model No.	Description	Type	Voltage (v)
CONSTANT CURRENT LED DRIVERS				
2503015121	87501087	LC 17/250-400/42 flexC SR SNC4	250-400mA	24-42V
2503015122	87501088	LC 25/450-600/42 flexC SR SNC4	450-600mA	24-42V
2503015123	87501089	LC 36/700-850/42 flexC SR SNC4	700-850mA	24-42V
2503015124	87501090	LC 42/900-1050/42 flexC SR SNC4	900-1050mA	24-42V
2450069296	87500992	LC 25/200-350/70 FLEXC LP SNC4	200-350mA	25-70V
2450069297	87500993	LC 35/200-350/121 FLEXC LP SNC4	200-350mA	52-121V
2450069299	87500994	LC 50/200-350/170 FLEXC LP SNC4	200-350mA	72-170V
2450069301	87500995	LC 65/200-350/210 FLEXC LP SNC4	200-350mA	90-210V

Emergency LED Drivers



TRIDONIC

5
YEAR
WARRANTY

100,000
HOUR LIFE

IP20

NEW

-  Emergency lighting LED driver for manual testing
-  For LED modules with a forward voltage of 10 - 54 V
-  Compatible with NiCD or NiMH batteries



Order No.	Model No.	Description	Wattage (w)
EMERGENCY LED DRIVERS			
2450012606	89800559	EMCONVERTERLED BASIC 203 NiCD/NiMH 50V	2.4
2450012608	89800560	EMCONVERTERLED BASIC 204 NiCD/NiMH 50V	3.5

Emergency LED Accessories

TRIDONIC



Order No.	Model No.	Description
EMERGENCY LED ACCESSORIES		
2450008039	89800270	Green Emergency Charging Indicator 300mm Leads & Connector Plug

Constant Current LED Drivers

Helvar

100,000
HOUR LIFE

IP20



- Selectable output current via DIP switches
- Built in cable clamp



Order No.	Model No.	Description
CONSTANT CURRENT LED DRIVERS		
2450013412	LC22MINI-CC-125-500-SR	125-500mA Selectable Output LED Driver
2450013413	LC42MINI-CC-300-1050-SR	300-1050mA Selectable Output LED Driver

Nickel Cadmium (NiCd) Emergency Lighting Batteries



Order No.	Model No.	Description	Voltage (V)	Amp Hour (Ah)
NICKEL CADMIUM (NiCd) EMERGENCY LIGHTING BATTERIES				
2450020301	2A6	2 Cell 'D' Cell Stick	2.4V	4AH
2450020302	3A6	3 Cell 'D' Cell Stick	3.6V	4AH
2450020303	4A6	4 Cell 'D' Cell Stick	4.8V	4AH
2450020304	5A6	5 Cell 'D' Cell Stick	6.0V	4AH
2450020305	6A6	6 Cell 'D' Cell Stick	7.2V	4AH
2450020306	2B6	2 Cell 'D' Cell Side by Side	2.4V	4AH
2450020307	3B6	3 Cell 'D' Cell Side by Side	3.6V	4AH
2450020308	4B6	4 Cell 'D' Cell Side by Side	4.8V	4AH
2450020309	5B6	5 Cell 'D' Cell Side by Side	6.0V	4AH
2450020310	160SCK5T3A6	3 Cell 'C' Cell Stick	3.6V	1.6AH
2450012178	B054	3 Cell 2AH NiCd Stick Battery	3.6V	2AH
2450070350	B086	3 Cell 1.8AH NiCd Stick Battery	3.6V	1.8AH
2450008530	B049	5 Cell 2H NiCd Stick + Stick Battery (2+3)	6.0V	2AH

Sealed Lead Acid Batteries



Order No.	Model No.	Description	Voltage (V)	Amp Hour (Ah)
SEALED LEAD ACID BATTERIES				
2500593124	NP3.2-12	12V 3.2AH Sealed Lead Acid Battery	12V	3.2AH
1050090792	NP4-12	12V 4AH Sealed Lead Acid Battery	12V	4AH
2500593114	NP7-12	12V 7AH Sealed Lead Acid Battery	12V	7AH
2500525250	NP12-12	12V 12AH Sealed Lead Acid Battery	12V	12AH
2500529989	NP17-12I	12V 17AH Sealed Lead Acid Battery	12V	17AH
1050090790	NP24-12I	12V 24AH Sealed Lead Acid Battery	12V	24AH
2450010134	NP38-12	12V 38AH Sealed Lead Acid Battery	12V	38AH
1050090775	NP65-12I	12V 65AH Sealed Lead Acid Battery	12V	65AH

Nickel Metal (NiMH) Hydride Emergency Lighting Batteries



Order No.	Model No.	Description	Voltage (v)	Amp Hour (Ah)
NICKEL METAL (NiMH) HYDRIDE EMERGENCY LIGHTING BATTERIES				
2450004183	B902	2 Cell 18700 Cell Stick	2.4V	4AH
2450004184	B903	3 Cell 18700 Cell Stick	3.6V	4AH
2450004185	B904	4 Cell 18700 Cell Stick + Stick (2+2)	4.8V	4AH
2450004186	B905	5 Cell 18700 Cell Stick + Stick (2+3)	6.0V	4AH
2450002976	B906	6 Cell 18700 Cell Stick + Stick (3+3)	7.2V	4AH

Lithium Iron Phosphate (LiFeP04) Emergency Lighting Batteries

TRIDONIC



Order No.	Model No.	Description	Voltage (v)	Amp Hour (Ah)
LITHIUM IRON PHOSPHATE (LiFeP04) EMERGENCY LIGHTING BATTERIES				
2503015050	28002318	2 Cell 6.4V 3AH Stick	6.4V	3AH
2503015051	28002319	2 Cell 6.4V 3AH Side by Side	6.4V	3AH
2450332208	28002320	3 Cell 9.6V 4.5AH Stick	9.6V	4.5AH
2503015052	28002321	3 Cell 9.6V 4.5AH Side by Side	9.6V	4.5AH

Nickel Metal (NiMH) Hydride Emergency Lighting Batteries



Order No.	Model No.	Description	Voltage (v)	Amp Hour (Ah)
NICKEL METAL (NiMH) HYDRIDE EMERGENCY LIGHTING BATTERIES				
2450069006	400LAH2AF	2 Cell 18700 Cell Stick	2.4V	4AH
2450069007	400LAH3AF	3 Cell 18700 Cell Stick	3.6V	4AH

Lithium Iron Phosphate (LiFeP04) Emergency Lighting Batteries



Order No.	Model No.	Description	Voltage (v)	Amp Hour (Ah)
LITHIUM IRON PHOSPHATE (LiFeP04) EMERGENCY LIGHTING BATTERIES				
2450012180	B091	2 Cell 6.4V 1.5AH Stick	6.4V	1.5AH
2450020430	B093	2 Cell 6.4V 3AH Stick	6.4V	1.5AH

Lampholders and Accessories

Image	Order No.	Model No.	Description
LAMP HOLDERS AND ACCESSORIES			
1	2450062991	AC26TC	26mm T8 Steel Terry Clip Screw
2	2450061826	ALH/S8	T8 Push On Lampholder
3	2450062779	PW/ALH/S8/1	T8 Push On Lampholder w/1m Prewired Flex
4	2450061859	ALH/G5/641	End Fix T5 Lampholder Horizontal Holes
5	2450005545	ALH/G5/282/1	End Fix T5 Lampholder Vertical Holes with Spring Adjuster
6	2450061829	ALH/E13/1	End Fix T8 Lampholder 13.5mm Thick with Spring Adjuster
7	2450061858	ALH/G5/620	T5 Tombstone Lampholder 16mm Lamp Centre Height
8	2450061824	ALH/255	T8 Tombstone Lampholder 22.5mm Lamp Centre Height
9	2450061825	ALH/255P	T8 Tombstone Lampholder with Peg 22.5mm Lamp Centre Height
10	2450005893	ALH/1458	Snap in T8 Lampholder 25.5x13.3 Cutout
11	2450004501	ALH/243	Snap in T8 Lampholder 2 hole fix 20mm hole centres
12	2450007939	ALH/902/NL	Twin Tube T8 Lampholder Snap In 25.5x13.3mm Cutout
13	2450068485	ALH/2D/G	2D Lamp 2 Pin GR8 Lampholder
14	2450061855	ALH/2D/413G	2D Lamp 4 Pin GR10q Lampholder
15	2450063000	ALH/PL	PL-S Lamp 2 Pin Lampholder Screw Fix
16	2450005530	ALH/2G11/E	PL-L Lamp 4 Pin Lampholder End Fix
17	2450002148	ALH/2G11/SUP/P	PL-L Lamp Support Clip Peg Fix 21.5mm Lamp Centre Height
18	2450061842	ALH/2G11/SUP/SI	PL-L Lamp Support Clip Snap In 21/24.5/27mm Lamp Centre Height
19	2450005532	ALH/2G11/SUP/MCP	PL-L Lamp Support Clip Metal Snap In 21.5mm Lamp Centre Height
20	2450004471	ALH/2G11/SUP/VIS/WH	PL-L Lamp Support Clip Vertical Snap In 15.5mm Lamp Centre Height
21	2450012176	ALH/R7B	R7s Linear Halogen Lamp Holder on Bracket Max 500w
22	2450319141	ALH/GXYZ/R	Low Voltage Halogen Lampholder G4, GU5.3, GY6.35
23	2450184896	ALH/LV/RET	Low Voltage Halogen Lamp Retaining Clip 50mm
24	2450064636	ALH/GU10/R	Mains Voltage GU10 Lampholder with 200mm Leads
25	2450061822	ALH/P/ES/SK	Porcelain ES Lampholder Internal Fixing
26	2450063027	ALH/P/ES/F	Porcelain ES Lampholder External Fixing
27	2450004737	ALH/BP/ES/BF	Brass ES Lampholder External Fixing
28	2450007959	ALH/PLA/ES/TH/BLK	Plastic ES Lampholder External Thread Black
29	2450063028	ALH/P/GES/S	Porcelain GES Lampholder Internal Fixing
30	2450061821	ALH/P/GES/S/BKT	Porcelain GES Lampholder External Fixing
31	2450004317	AFTB5	Fused Terminal Block Screw Fix Screw Input Pushwire Output
32	2450002133	AFTB7	Fused Terminal Block Screw Fix Screw Input & Output
	2450070325	11596	Adaptor for ES lamp to GES fitting
	2450070326	11597	Adaptor for GES lamp to ES fitting
33	2450007956	4905	Adaptor for BC lamp to ES fitting

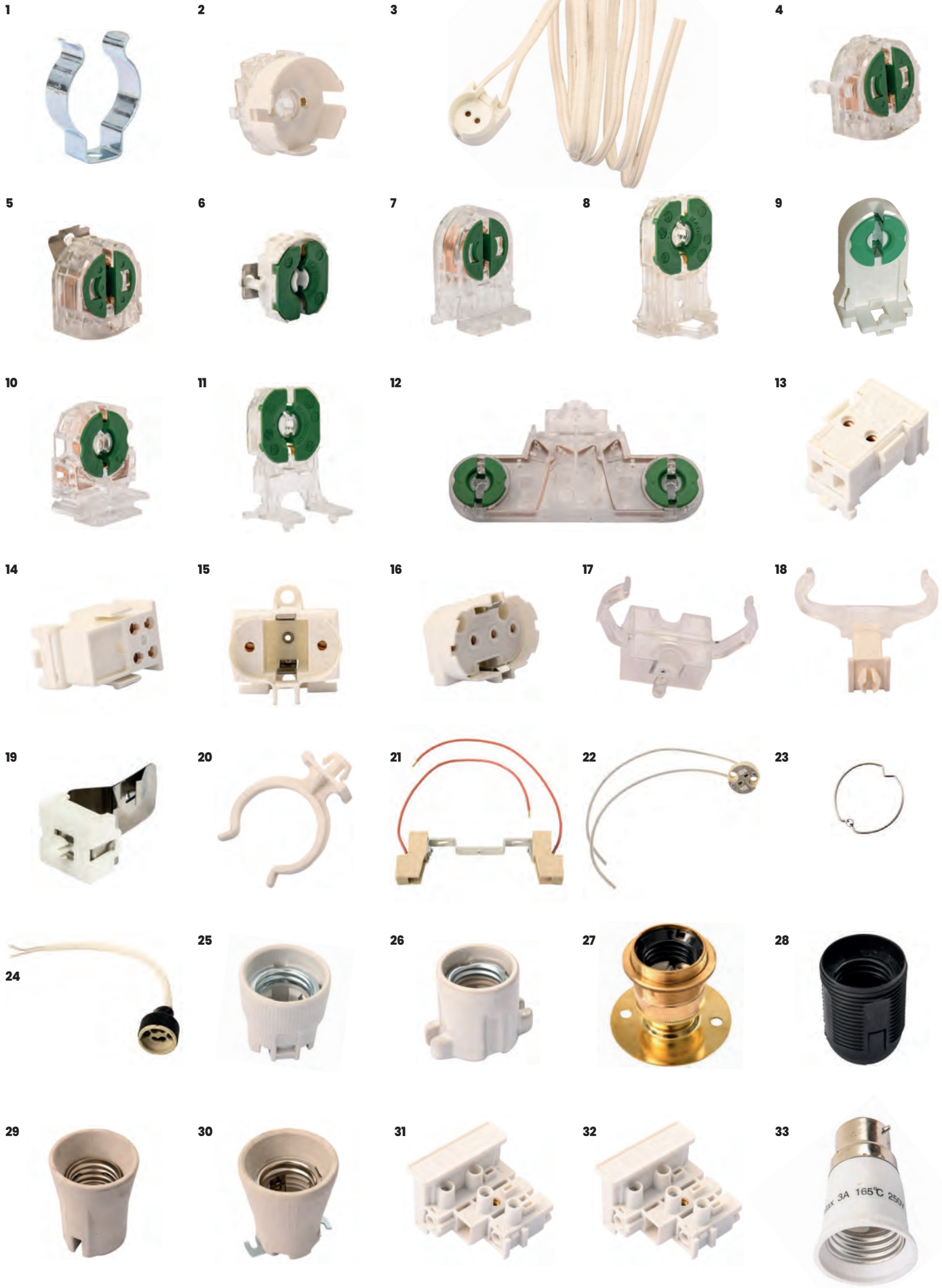

Our certification

Rexel holds certification against the ISO standards for Energy Management (ISO50001), Environmental Management (ISO14001), Quality Management (ISO9001) and Health & Safety Management (ISO45001). The standards cover all our operations in the UK. ISO14001 and ISO50001 have embedded strategic management of energy and environmental aspects into business processes and have annual objectives aimed at reducing Rexel's carbon footprint.



Reducing Rexel's global carbon footprint

Rexel aims to be Net Zero by 2050. We aim to reduce operational impacts (Scope 1 & 2) by 60% by 2030, against the 2016 baseline.

Find out more about how we are continuing to improve our environmental performance at www.rexel.co.uk/uki/sustainability or scan the QR code



Useful Information

Colour Temperature Guide (Kelvins)

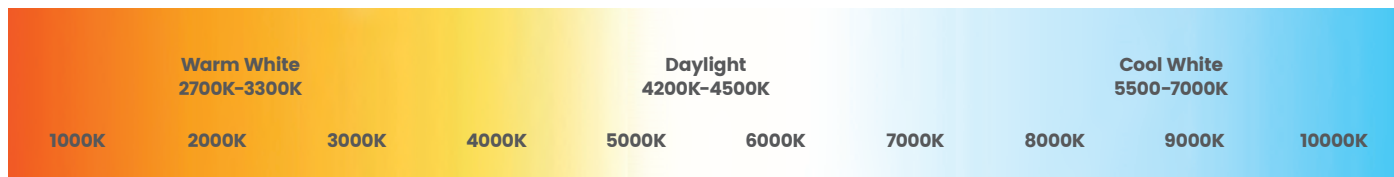

RoHS Update – Fluorescent Lamps

	Phase Out 24/02/2023	Phase Out 1/09/2023	Phase Out 01/02/2024	Phase Out 24/02/2025
Non Linear Fluorescent Lamps TL-E Circular (T9), TL5 Circular, TL-D U	Grey	Grey	Grey	Grey
Linear Fluorescent T8 2ft, 4ft & 5ft	Blue	Grey	Grey	Grey
Linear Fluorescent T8 Other Lengths	Blue	Blue	Grey	Grey
Linear Fluorescent T5 High Efficiency & High Output	Blue	Blue	Grey	Grey
Linear Fluorescent T8 & T5 Long Life >25,000 Hours	Blue	Blue	Grey	Grey
Compact Fluorescents - Non Integrated PL-C, PL-S, PL-T, PL-L, PL-R, PL-Q	Blue	Blue	Grey	Grey
Compact Fluorescents - Non Integrated - Long Life PL-C, PL-T, PL-L Xtra	Blue	Blue	Blue	Grey

Class Guide



Class 1 – the fitting is insulated and earthed. If the insulation ceases to be affected, accessible metal parts of the fitting will be protected by the earth.



Class 2 – Fittings are designed and constructed to offer higher standards of electrical safety. They have reinforced insulation or double insulation and do not need to be earthed.



Class 3 – Fittings are intended for use with low voltage Max 50V, in conformity with SELV.

Standard LED luminaires warranty

We offer a minimum 2-year warranty* on all products that have been correctly specified, professionally installed and operated in line with the instruction leaflet.

If a product fails during this period, Rexel will arrange for the product to be repaired or replaced with an equal or substitute product at our discretion.

*Wearing or consumable parts such as fuses and emergency lighting batteries are exempt from the guarantee. All sales are subject to Rexel UK Limited standard terms and conditions of sale. In the event of any conflict between the wording set out in this document and the standard terms, the standard terms of Rexel UK Limited shall prevail.

Cap Guide

 2G10	 2G11	 2G13	 2G7	 2GX13	 B15/B15d
 B15s/BA15s	 B21s	 B22/B22d	 B22d-3	 BA9s	 BA15d
 BA20d	 BA20	 BA21d	 BY22d	 E10-13	 E12
 E14	 E26	 E27	 E39	 E40	 EZ10
 FC2	 G10q	 G10.2q	 G12	 G13	 G13 Xtra/Xtreme
 G22	 G23	 G24d-1	 G24d-2	 G24d-3	 G24q-1
 G24q-2	 G24q-3	 G3.9	 G38	 G4	 G5
 G5 Xtra	 G5.3	 G53	 G5.3-4.8	 G6.35/GX6.35/GY6.35	 G8.5

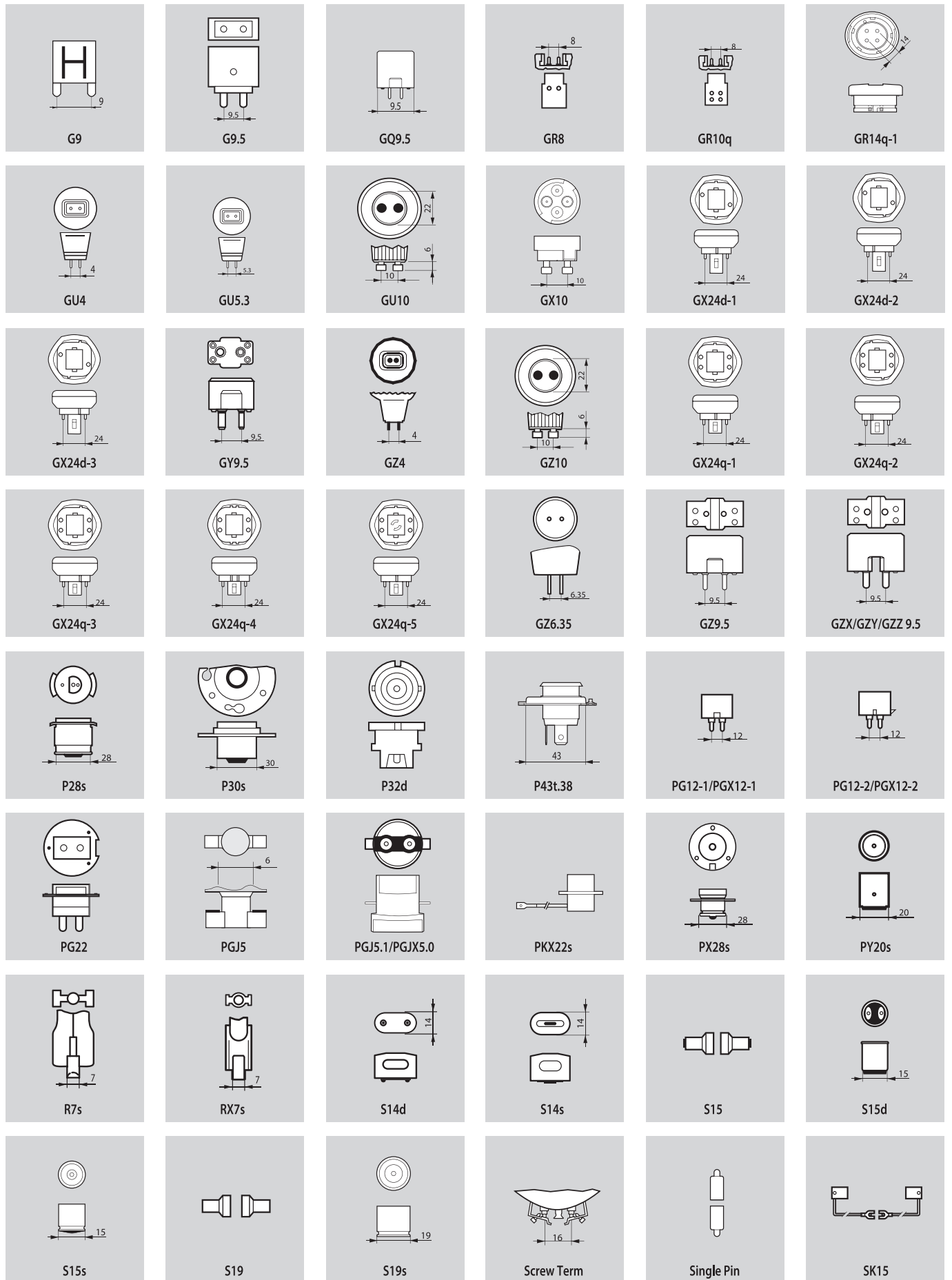

REXEL

Denmans
REXEL GROUP

Our terms and conditions of sale apply to the sale of goods to the exclusion of all other terms. A copy of our terms is available at www.rexel.co.uk. The information in this document is for general information purposes only. Rexel UK Limited assumes no responsibility in so far as the law permits for errors or omissions in the contents of this document. No reliance shall be placed on the contents by readers.

250+ Branches Nationwide Scan here for our Branch Locator

